

The Garador Range Spares Catalogue

1st March 2025

Up & Over Doors, Side-Hinged Doors and Operators

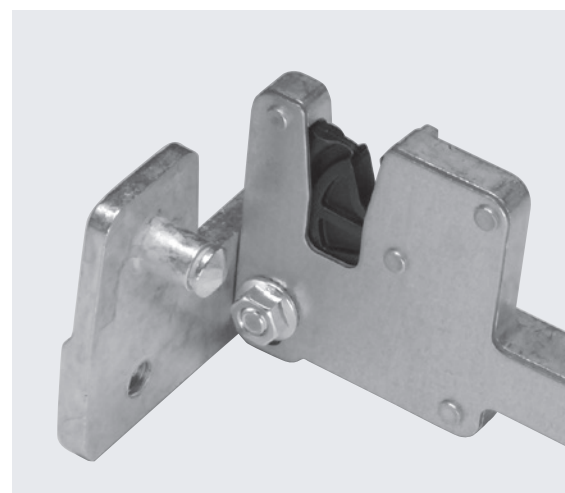

General Information

All prices are quoted in £ Sterling, ex-works and exclusive of VAT.

Our doors are for residential purposes only and not for commercial use.

All orders for spares will be subject to a minimum P&P charge, please check cost when ordering. All items are listed and priced as single items unless specified.

Please ensure that you order the correct component for your specific door, parts ordered incorrectly will be subject to a restocking charge if being returned. For handing of component, the door should be viewed from the inside, looking at the back of the panel. Please contact Garador on 01935 443722 if you need assistance in identifying the correct part.

Since the company's policy is one of continuous improvement of its products, we reserve the right to make any alterations in design, manufacture or price.

All business is governed by the Company's Standard Conditions and this document does not form any part of any contract with the company and statements contained in it should not be construed as representations or warranties.



For more information please visit
www.garador.co.uk





Contents

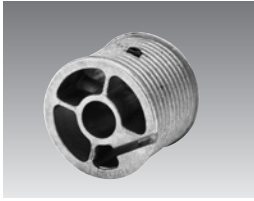
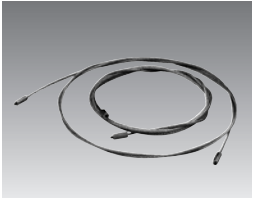
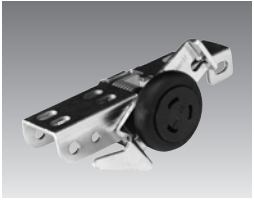

Up & Over Doors (2002 - current)	4
Canopy Doors	4
Retractable Doors	6
Retractable Plus Doors	8
Handles, Lock Assembly and Keys	11
Weather seal components	13
Up & Over Doors (Pre 2002)	14
Pre-2002 Spring Ref No. Conversion Chart	14
Mark 3C Accessories for Overhead Spring Box Pre 1999 (canopy)	20
Accessories for Mark 4 / F-Type Doors (canopy)	25
Accessories for doors with C Type Side Extension Springs 1999 - 2002 (canopy)	30
Single and Double Retractable Gear Components	35
Double Canopy Doors	36
Handles, Lock Assemblies and Keys	39
Garage Side Doors (2002 - current)	40
Sectional Garage Doors (2002 - current)	41
Springs and Brackets	41
Cones and Drums	44
Tension Spring Assembly	45
Torsion Spring Assembly	46
Lifting Cables	47
Frame Fitting Packs	48
Seals and Profiles	49
Electric Operators	50
GaraMatic Operators	50
EuroPro	55
Consumables	56
Bulbs and Batteries	56
Touch Up Paint	57
Warranty	58

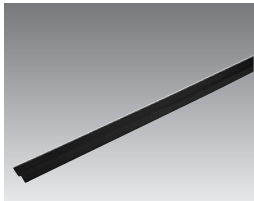
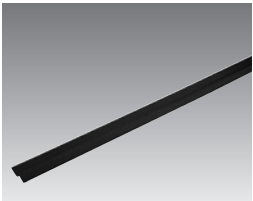
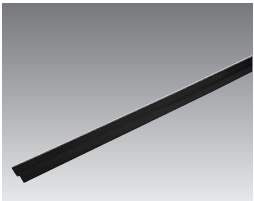
Canopy Doors

				
Article	Cable Drum 2002 - current.	Canopy Cables Sold in pairs. 2002 - current.	Safety Latch and Roller For canopy doors. 2002 - current.	Door Top Weatherstrip 2002 - current.
Ref. No.	(LH) 57, (RH) 58	45	(LH) 127, (RH) 128	110
Price £	22.00	42.00 (per pair)	43.00	26.00

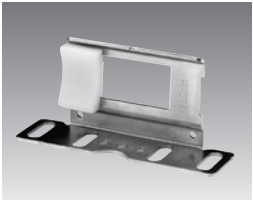
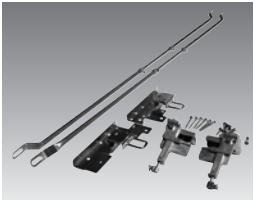
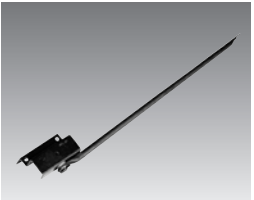
				
Article	Bottom Weatherstrip for Timber Frame Cut to length. 2002 - current.	Rubbing Strip for Steel Frame Cut to length. 2002 - current.	Bottom Weather Strip for Steel Frame Specify door height when ordering. 2002 - current.	Spring Assembly Specify door width when ordering. 2002 - current.
Ref. No.	111	109	108	1223 (state size on order)
Price £	26.00	27.00	27.00	128.00

				
Article	Door Latch Assembly 2002 - current.	Door Latch Keeper 2002 - current.	Additional Lock Kit For canopy doors. 2003 - current.	Canopy Link Arm Assembly Steel/Timber (2002 - current) & GRP (2006 - current).
Ref. No.	122	126	1768	145
Price £	19.00	19.00	84.00	66.00



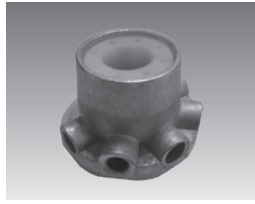

			
Article	Canopy Link Arm Assembly GRP 2002 - 2006.	Canopy Track Assembly Includes cable and roller. Sold in pairs. 2002 - current.	Canopy Tensioning Bars Sold in pairs.
Ref. No.	187	160161	1222
Price £	66.00	165.00	28.00

Canopy Doors







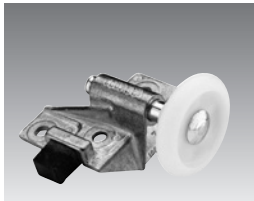
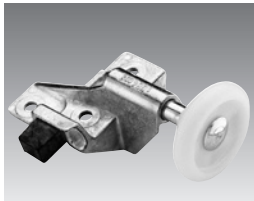
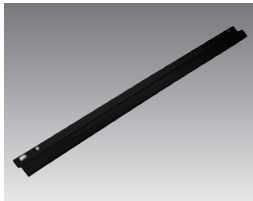
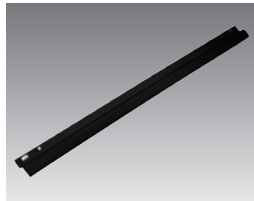

Article	Left Spring Cone	Right Spring Cone
Ref. No.	59	60
Price £	24.00	24.00

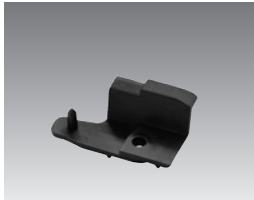
Retractable Doors

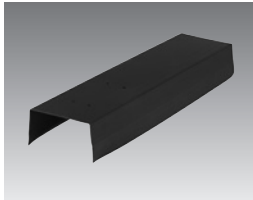
				
Article	Retractable Spring Assembly 001 2002 - current.	Retractable Spring Assembly 002 2002 - current.	Retractable Spring Assembly 003 2002 - current.	Retractable Spring Assembly 004 2002 - current.
Ref. No.	52	53	54	1226
Price £	64.00 (each)	64.00 (each)	64.00 (each)	64.00 (each)

				
Article	Roller Bracket Assembly For all framed retractable doors. 2002 - 2003.	Roller Bracket Assembly For all framed retractable doors. 2003 - current.	Retractable Top Weatherstrip For 6'6" high door.	Retractable Top Weatherstrip For 7'0" high door.
Ref. No.	(LH) 123, (RH) 124	(LH) 120, (RH) 121	104	105
Price £	52.00	43.00	26.00	26.00

				
Article	Pivot Block (Panel) For retractable doors. 2004 - current.	Pivot Block (Frame) 2004 - current.	Finger Trap Protection For retractable doors. 2004 - current.	Retractable Link Arm Assembly for steel frame 6'4" 2002 - current.
Ref. No.	(LH) 251, (RH) 252	(LH) 88, (RH) 89	100	(LH) 4668, (RH) 4669
Price £	24.00	22.00	23.00	53.00

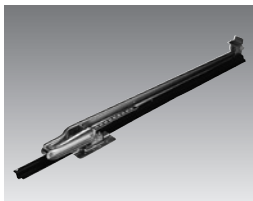
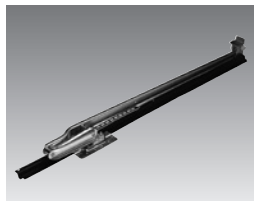
				
Article	Retractable Link Arm Assembly for steel frame 6'6" 2002 - current.	Retractable Link Arm Assembly for steel frame 7'0" 2002 - current.	Retractable Link Arm Assembly for timber frame 6'4" 2002 - current.	Retractable Link Arm Assembly for timber frame 6'6" 2002 - current.
Ref. No.	(LH) 4670, (RH) 4671	(LH) 4672, (RH) 4673	(LH) 4834, (RH) 4835	(LH) 4836, (RH) 4837
Price £	53.00	53.00	67.00	67.00

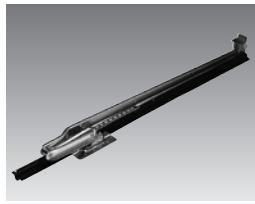
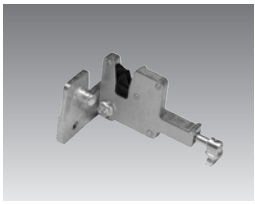
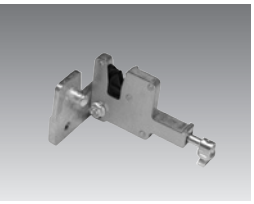
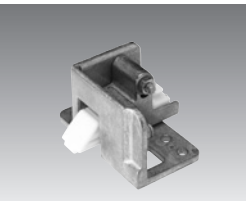

Retractable Doors

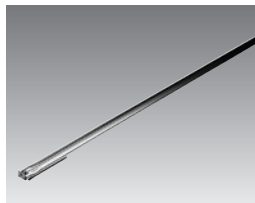
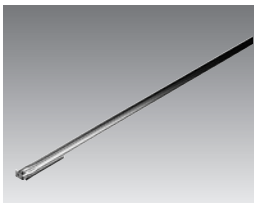
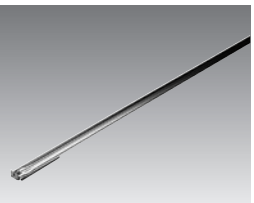
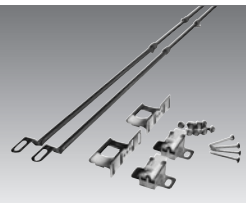

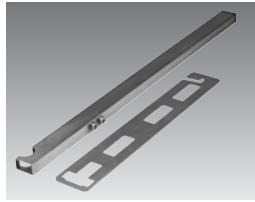
				
Article	Retractable Link Arm Assembly For timber frame. 7'0" 2002 - current.	Retractable Latch For steel doors. 2005 - current.	Retractable Latch Gold in colour. For timber doors (2005 - current) & GRP doors (2006 - current).	Retractable Latch For steel doors (2002 - 2003) and GRP Doors (2002 - 2006).
Ref. No.	(LH) 4838, (RH) 4839	(LH) 2790, (RH) 2791	(LH) 3076, (RH) 3077	(LH) 180, (RH) 181
Price £	67.00	45.00	45.00	45.00

				
Article	Retractable Track Assembly Up to 10'0" wide - 6'4" high. Unframed doors only. 2002 - current.	Retractable Track Assembly Up to 10'0" wide - 6'6" high. Unframed doors only. 2002 - current.	Retractable Track Assembly Up to 10'0" wide - 7'0" high. Unframed doors only. 2002 - current.	Additional Lock Kit For retractable doors. 2003 - current.
Ref. No.	(LH) 269, (RH) 270	(LH) 271, (RH) 272	(LH) 273, (RH) 274	1769
Price £	64.00	64.00	64.00	84.00

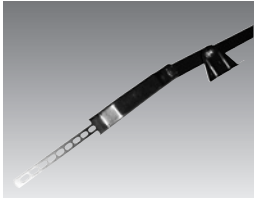
	
Article	Tensioning Tool For retractable doors. 2002 - current.
Ref. No.	1909
Price £	118.00

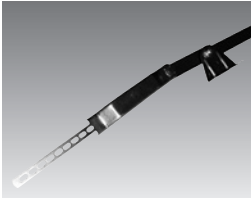

Retractable Plus Doors

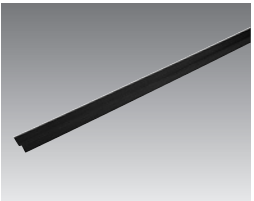
			
Article	Retractable Plus Link Arm Assembly For timber and steel frame. 6'4" Weather strip not included.	Retractable Plus Link Arm Assembly For timber and steel frame. 6'6" Weather strip not included.	Retractable Plus Link Arm Assembly For timber and steel frame. 7'0"
Ref. No.	2617	2618	2619
Price £	64.00	64.00	70.00

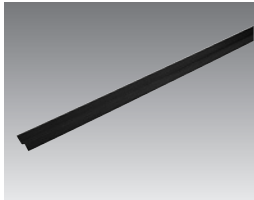
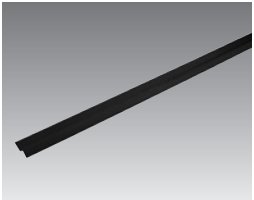
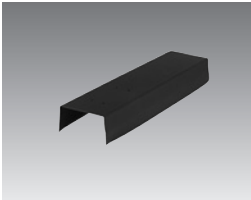

				
Article	Top Weather Strip For 6'4" retractable plus doors, timber and steel frame. 2005 - current.	Top Weather Strip For 6'6" retractable plus doors, timber and steel frame. 2005 - current.	Top Weather Strip For 7'0" retractable plus doors, timber and steel frame. 2005 - current.	Bottom Weather Strip For 6'4" retractable plus doors, timber and steel frame. 2005 - current.
Ref. No.	2677	1709	1710	2675
Price £	26.00	26.00	26.00	28.00

			
Article	Bottom Weather Strip For 6'6" retractable plus doors, timber and steel frame. 2005 - current.	Bottom Weather Strip For 7'0" retractable plus doors, timber and steel frame. 2005 - current.	Finger Trap Protection For retractable plus doors. 2005 - current.
Ref. No.	1699	1700	1844
Price £	28.00	28.00	23.00

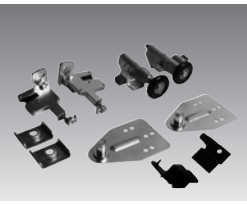
Double Retractable Doors

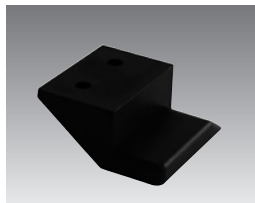
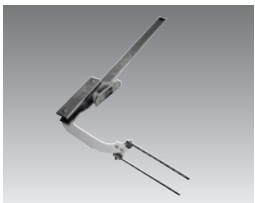
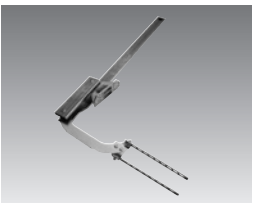
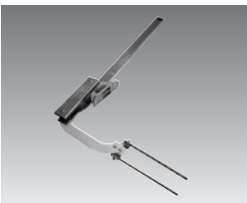
				
Article	Double Door Spring Assembly 4er 025 2004 - current.	Double Door Spring Assembly 4er 032 2004 - current.	Double Door Spring Assembly 023 2004 - current.	Double Door Latch and Roller Pack
Ref. No.	1946	1945	4346	4333
Price £	84.00 (each)	84.00 (each)	84.00 (each)	165.00

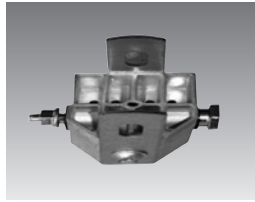
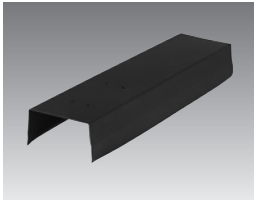
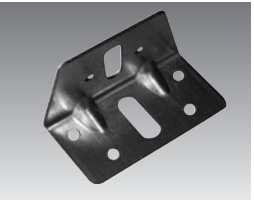
				
Article	Frame Pivot Block For double doors.	Link Arm 1931 mm 6'4" 2009 - current.	Link Arm 1980 mm 6'6" 2009 - current.	Link Arm 2036 mm 7'0" 2009 - current.
Ref. No.	(LH) 4272, (RH) 4273	(LH) 6013, (RH) 6014	(LH) 4278, (RH) 4279	(LH) 4280, (RH) 4281
Price £	22.00	146.00	146.00	146.00

				
Article	Spring Coupling Bracket For double doors.	Finger Trap Protection For double doors.	Track/Wall Bracket For double doors.	N800 Double Door Latch Keeper For steel frames.
Ref. No.	4379	4285	4284	(LH) 4275, (RH) 4276
Price £	71.00	23.00	26.00	85.00

				
Article	N800 Double Door Latch Keeper For timber frames.	N800 Double Door Track 2136 mm (Right Hand)	N800 Double Door Track 2136 mm (Left Hand)	N800 Double Door Track 1931 mm (Right Hand)
Ref. No.	(LH) 4306, (RH) 4307	437600002	437500002	437600008
Price £	85.00	89.00	89.00	89.00

Double Retractable Doors

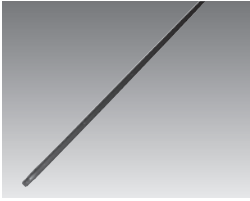
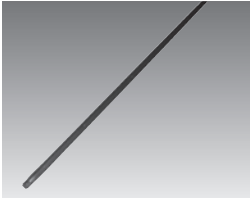
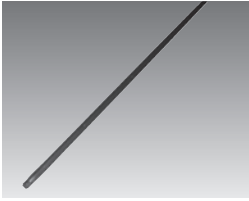
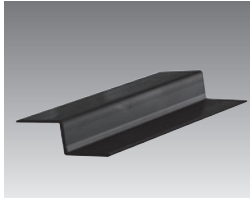
				
Article	N800 Double Door Track 1931 mm (Left Hand)	N800 Double Door Track 1981 mm (Right Hand)	N800 Double Door Track 1981 mm (Left Hand)	Bottom Frame Weatherstrip 1980/2136 For double doors 6'6" high.
Ref. No.	437500008	437600001	437500001	4310
Price £	89.00	89.00	89.00	30.00

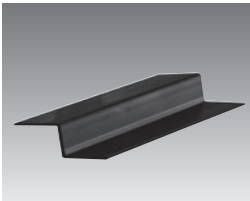
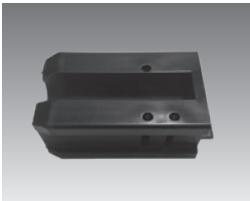
		
Article	Bottom Frame Weatherstrip 1980/2136 For double doors 7'0 high.	Retractable Connecting Block
Ref. No.	4311	81
Price £	30.00	19.00





Handles, Lock Assembly and Keys

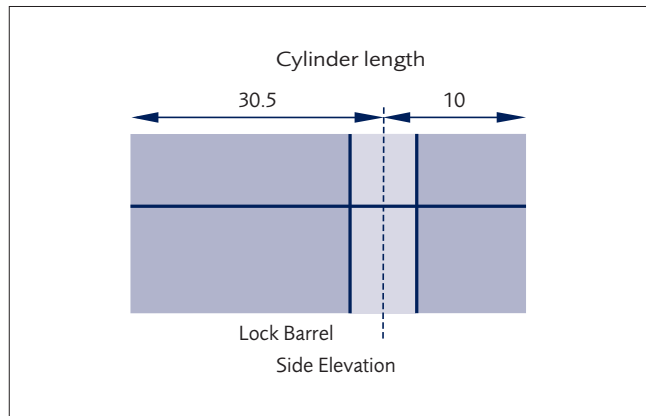



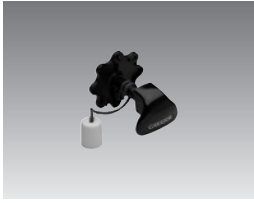

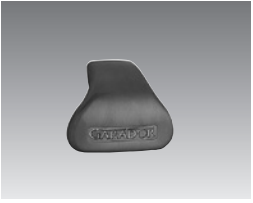
	Doortype	Cylinder Length	Ref. No.	Price £
Lock Body with Cylinders (2003 - Current)	Suitable for all Carlton, Horizon, Salisbury, Sutton, Chevron and all double steel doors	30.5 + 10	204	54.00
Lock Body with Cylinders (2003 - Current)	Suitable for all Georgian, Beaumont, Cathedral, Sherwood and Wentwood doors	35 + 10	202	54.00
Lock Body with Cylinders (2003 - Current)	Suitable for all Tudor, Seymour, Wolsey, Shaftsbury and single GRP doors	40 + 10	203	66.00
Lock Body with Cylinders (2002 - Current)	Suitable for all GRP and timber doors	50.5 + 10	1796	66.00
Lock Body with Cylinders (2003 - Current)	Suitable for all Sandhurst, Chevron Cedar, Kingsbury, Barrington, Bosworth and all double GRP doors	55.5 + 10	2078	66.00

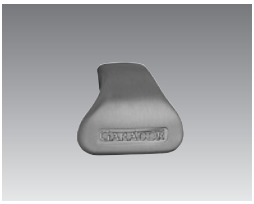

Handles, Lock Assembly and Keys

				
Article	Standard Black Handle All steel doors. 2002 - current.	Standard Black Handle (adjustable and fascia) All timber and GRP doors. 2002 - current.	Brass Effect Handle For up & over doors. 2002 - current.	Chrome Effect Handle For up & over doors. 2002 - current.
Ref. No.	550	7258	5072	5073
Price £	24.00	34.00	101.00	101.00

				
Article	White Effect Handle For up & over doors. 2002 - current.	Brushed Steel Effect Handle For up & over doors. 2002 - current.	Brass Fascia Plate For up & over doors. 2002 - current.	Chrome Fascia Plate For up & over doors. 2002 - current.
Ref. No.	5071	6460	3161	3162
Price £	101.00	101.00	27.00	27.00

		
Article	White Fascia Plate For up & over doors. 2002 - current.	Brushed Steel Fascia Plate For up & over doors. 2002 - current.
Ref. No.	3160	7648
Price £	27.00	27.00

Weather seal components

				
Article	Bottom Weather Seal Length 2405 mm (15 mm profile).	Bottom Weather Seal Length 3000 mm (15 mm profile).	Glue Down Rubber Weatherseal Approx 2.5 m length.	Brushstrip Approx 2.5m length.
Ref. No.	7841	7842	1837	1196
Price £	63.00	70.00	80.00	50.00

Pre-2002 Spring Ref No. Conversion Chart

C Type overhead spring box fitted to a timber frame - Ref. No.	Spring No.
4739	S1703001-3-1
4740	S1703001-3-2
4741	S1703001-3-3
4742	S1703001-3-4
4743	S1703001-3-6
4744	S1703001-3-8
4745	S1703001-3-9
4746	S1703001-3-10
4747	S1703001-3-11

C Type side extension spring fitted to a timber frame - Ref. No.	Spring No.
4733	G230-18-1
4734	G230-18-2
4735	G230-18-3
4736	G230-18-4
4737	G230-18-5
4738	G230-18-6

F type & MK 4 spring - Ref. No.	Spring No.
2149	S4-401
2150	S4-402
2151	S4-404
2152	S4-405
2153	S4-407

R, FR & DR spring - Ref. No.	Spring No.
4763	108-901
4764	108-903
4765	108-905
4766	108-907
4767	108-909
4768	108-911
4769	108-913
4770	108-915
4774	108-921
4775	108-923
4776	108-925
4777	108-927

DC Type spring - Ref. No.	Spring No.
4748	108-701
4749	108-703
4750	108-705
4751	108-707
4752	108-709
4753	108-711
4754	108-713
4755	108-721
4756	108-723
4757	108-725
4758	108-727

Canopy Doors

Mark 3C Springs Suitable for Overhead Spring Box fitted to a timber frame - Steel Panel Doors

Used on all Canopy doors pre 1999. Springs priced and supplied individually. However, it is always recommended that both springs are replaced at the same time.



For price, please see page 20

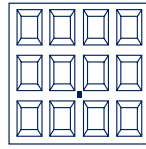

Georgian/Georgian Elite

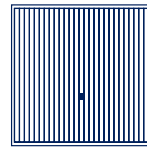

Carlton/Carlton Elite

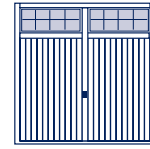

Salisbury/Salisbury Elite

	Spring box number	Spring box spring	No. of bands & Colour	Spring box number	Spring box spring	No. of bands & Colour	Spring box number	Spring box spring	No. of bands & Colour
6'6"x6'3"	-	-	-	PN58	4739	1 x Silver	-	-	-
6'6"x6'6"	PN167	4743	None	PN58	4739	1 x Silver	-	-	-
6'6"x7'0"	PN167	4743	None	PN58	4739	1 x Silver	-	-	-
7'0"x6'3"	-	-	-	N/A	N/A	N/A	-	-	-
7'0"x6'6"	PN57/1	4740	1 x Blue	PN58	4739	1 x Silver	PN55/2	4742	3 x Blue
7'0"x7'0"	PN150	4746	None	PN55/2	4742	3 x Blue	PN155	4747	1 x Orange
7'3 1/2"x6'4"	-	-	-	PN57/1	4740	1 x Blue	-	-	-
7'5"x6'3"	-	-	-	-	-	-	-	-	-
7'5"x6'6"	PN55/2	4742	3 x Blue	PN57/1	4740	1 x Blue	PN155	4747	1 x Orange
7'5"x7'0"	PN108	4745	2 x Orange	PN150	4746	None	PN108	4745	2 x Orange
7'6"x6'6"	PN55/2	4742	3 x Blue	PN57/1	4740	1 x Blue	PN155	4747	1 x Orange
7'6"x7'0"	N/A	N/A	N/A	N/A	N/A	N/A	N/A	N/A	N/A
7'8 1/2"x6'3"	-	-	-	N/A	N/A	N/A	-	-	-
7'8 1/2"x6'6 3/4"	PN150	4746	None	PN55/2	4742	3 x Blue	-	-	-
7'8 1/2"x6'11 3/4"	N/A	N/A	N/A	PN155	4747	1 x Orange	-	-	-
8'0"x6'3"	-	-	-	N/A	N/A	N/A	-	-	-
8'0"x6'6"	PN150	4746	None	PN55/2	4742	3 x Blue	PN150	4746	None
8'0"x7'0"	PN108	4745	2 x Orange	PN155	4747	1 x Orange	PN155	4747	1 x Orange
8'2 1/2"x6'3"	-	-	-	N/A	N/A	N/A	-	-	-
8'2 1/2"x6'6 3/4"	-	-	-	PN150	4746	None	-	-	-
8'2 1/2"x6'11 3/4"	-	-	-	PN155	4747	1 x Orange	-	-	-



For price, please see page 20

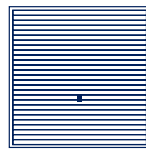

Horizon/Horizon Elite

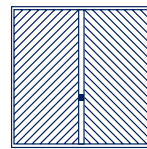

Chevron/Chevron Elite

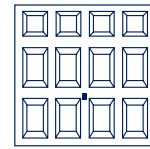

Beaumont/Beaumont Elite

	Spring box number	Spring box spring	No. of bands & Colour	Spring box number	Spring box spring	No. of bands & Colour	Spring box number	Spring box spring	No. of bands & Colour
6'6"x6'3"	PN58	4739	1 x Silver	-	-	-	-	-	-
6'6"x6'6"	PN58	4739	1 x Silver	PN167	4743	None	-	-	-
6'6"x7'0"	PN58	4739	1 x Silver	PN167	4743	None	-	-	-
7'0"x6'3"	N/A	N/A	N/A	-	-	-	-	-	-
7'0"x6'6"	PN58	4739	1 x Silver	PN57/1	4740	1 x Blue	4742	3 x Blue	
7'0"x7'0"	PN57/1	4740	1 x Blue	PN55/2	4742	3 x Blue	4747	1 x Orange	
7'3 1/2"x6'4"	PN56/1	4741	2 x Blue	-	-	-	-	-	-
7'5"x6'3"	N/A	N/A	N/A	-	-	-	-	-	-
7'5"x6'6"	PN56/1	4741	2 x Blue	PN55/2	4742	3 x Blue	4742	3 x Blue	

Canopy Doors

7'5"x7'0"	PN55/2	4742	3 x Blue	PN155	4747	1 x Orange	-	-	-
7'6"x6'6"	PN57/1	4740	1 x Blue	PN55/2	4742	3 x Blue	-	-	-
7'6"x7'0"	N/A	N/A	N/A	N/A	N/A	N/A		4747	1 x Orange
7'8½"x6'3"	N/A	N/A	N/A	-	-	-	-	-	-
7'8½"x6'6¾"	PN115	4744	2 x Silver	PN55/2	4742	3 x Blue	-	-	-
7'8½"x6'11¾"	PN55/2	4742	3 x Blue	PN155	4747	1 x Orange	-	-	-
8'0"x6'3"	N/A	N/A	N/A	-	-	-	-	-	-
8'0"x6'6"	PN115	4744	2 x Silver	-	-	-	-	-	-
8'0"x7'0"	PN150	4746	None	-	-	-	-	-	-
8'2½"x6'3"	N/A	N/A	N/A	-	-	-	-	-	-
8'2½"x6'6¾"	PN55/2	4742	3 x Blue	-	-	-	-	-	-
8'2½"x6'11¾"	PN155	4747	1 x Orange	-	-	-	-	-	-

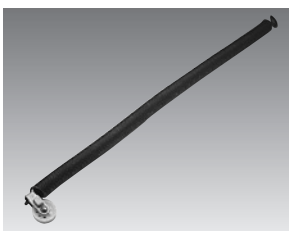

For price, please see page 20

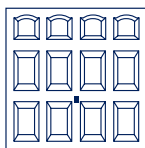

Cathedral/Cathedral Elite

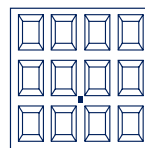

Parade White/Brown

	Spring box number	Spring box spring	No. of bands & Colour	Spring box number	Spring box spring	No. of bands & Colour
6'6"x6'3"	-	-	-	-	-	-
6'6"x6'6"	-	-	-	PN167	4743	None
6'6"x7'0"	-	-	-	-	-	-
7'0"x6'3"	-	-	-	-	-	-
7'0"x6'6"	PN55/2	4742	3 x Blue	PN57/1	4740	1 x Blue
7'0"x7'0"	PN155	4747	1 x Orange	PN155	4747	1 x Orange
7'3½"x6'4"	-	-	-	-	-	-
7'5"x6'3"	-	-	-	-	-	-
7'5"x6'6"	PN55/2	4742	3 x Blue	PN155	4747	1 x Orange
7'5"x7'0"	-	-	-	PN155	4747	1 x Orange
7'6"x6'6"	-	-	-	N/A	N/A	N/A
7'6"x7'0"	PN155	4747	1 x Orange	N/A	N/A	N/A
7'8½"x6'3"	-	-	-	-	-	-
7'8½"x6'6¾"	-	-	-	-	-	-
7'8½"x6'11¾"	-	-	-	-	-	-
8'0"x6'3"	-	-	-	-	-	-
8'0"x6'6"	-	-	-	PN155	4747	1 x Orange
8'0"x7'0"	-	-	-	PN108	4745	2 x Orange
8'2½"x6'3"	-	-	-	-	-	-
8'2½"x6'6¾"	-	-	-	-	-	-
8'2½"x6'11¾"	-	-	-	-	-	-

Canopy Doors

Mark 3C Springs Suitable for Overhead Spring Box fitted to a timber frame - GRP Premier Panel Doors

Used on all Canopy doors pre 1999. Springs priced and supplied individually. However, it is always recommended that both springs are replaced at the same time.



For price, please see page 20

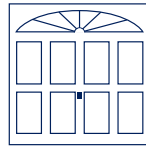

Stamford

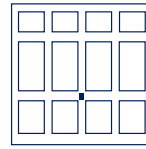

Arden

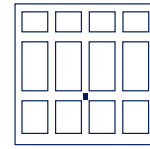

Kenmore

	Spring box number	Spring box spring	No. of bands & Colour	Spring box number	Spring box spring	No. of bands & Colour	Spring box number	Spring box spring	No. of bands & Colour
7'0"x6'6"	N/A	N/A	N/A	PN55/2	4742	3 x Blue	PN55/2	4742	3 x Blue
7'0"x7'0"	N/A	N/A	N/A	PN55/2	4742	3 x Blue	PN55/2	4742	3 x Blue
7'5"x6'6"	N/A	N/A	N/A	PN155	4747	1 x Orange	PN155	4747	1 x Orange
7'6"x7'0"	N/A	N/A	N/A	PN155	4747	1 x Orange	PN155	4747	1 x Orange



For price, please see page 20

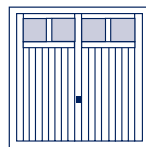

Derwent

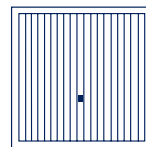

Swinton

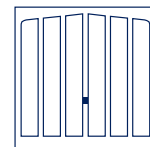

Clifton

	Spring box number	Spring box spring	No. of bands & Colour	Spring box number	Spring box spring	No. of bands & Colour	Spring box number	Spring box spring	No. of bands & Colour
7'0"x6'6"	N/A	N/A	N/A	PN55/2	4742	3 x Blue	PN55/2	4742	3 x Blue
7'0"x7'0"	N/A	N/A	N/A	PN55/2	4742	3 x Blue	PN55/2	4742	3 x Blue
7'5"x6'6"	N/A	N/A	N/A	PN155	4747	1 x Orange	PN155	4747	1 x Orange
7'6"x7'0"	N/A	N/A	N/A	PN155	4747	1 x Orange	PN155	4747	1 x Orange



For price, please see page 20

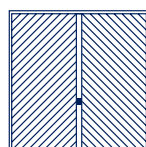

Oakham

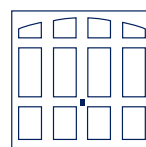

Woburn

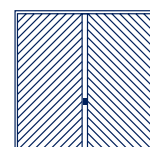

Wentwood

	Spring box number	Spring box spring	No. of bands & Colour	Spring box number	Spring box spring	No. of bands & Colour	Spring box number	Spring box spring	No. of bands & Colour
7'0"x6'6"	PN55/2	4742	3 x Blue	N/A	N/A	N/A	PN55/2	4742	3 x Blue
7'0"x7'0"	PN55/2	4742	3 x Blue	N/A	N/A	N/A	PN155	4747	1 x Orange
7'5"x6'6"	PN155	4747	1 x Orange	N/A	N/A	N/A	PN55/2	4742	3 x Blue
7'6"x7'0"	PN155	4747	1 x Orange	N/A	N/A	N/A	PN155	4747	1 x Orange

Canopy Doors

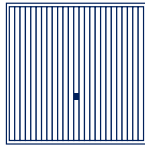
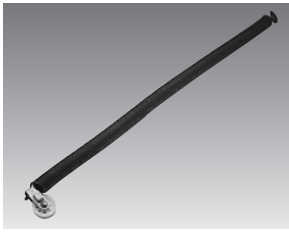

Sherwood

For price, please see page 20

	Spring box number	Spring box spring	No. of bands & Colour
7'0"x6'6"	PN55/2	4742	3 x Blue
7'0"x7'0"	PN155	4747	1 x Orange
7'5"x6'6"	PN55/2	4742	3 x Blue
7'6"x7'0"	PN155	4747	1 x Orange

Canopy Doors

Mark 3C Springs Suitable for Overhead Spring Box fitted to a timber frame - Timber Panel Doors

Used on all Canopy doors pre 1999. Springs priced and supplied individually. However, it is always recommended that both springs are replaced at the same time.



For price, please see page 20

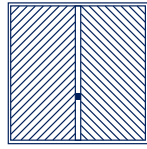

Chevron Cedar

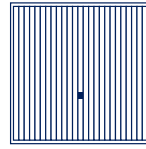

Vertical Cedar

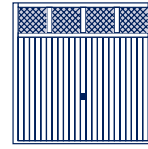

Sandhurst

	Spring box number	Spring box spring	No. of bands & Colour	Spring box number	Spring box spring	No. of bands & Colour	Spring box number	Spring box spring	No. of bands & Colour
7'0"x6'6"	PN57/1	4740	1 x Blue	PN57/1	4740	1 x Blue	-	-	-
7'0"x7'0"	PN55/2	4742	3 x Blue	PN55/2	4742	3 x Blue	PN55/2	4742	3 x Blue
7'5"x6'6"	PN55/2	4742	3 x Blue	PN57/1	4740	1 x Blue	PN55/2	4742	3 x Blue
7'5"x7'0"	PN55/2	4742	3 x Blue	PN150	4746	None	PN55/2	4742	3 x Blue
7'6"x6'6"	PN55/2	4742	3 x Blue	PN55/2	4742	3 x Blue	PN55/2	4742	3 x Blue
7'6"x7'0"	-	-	-	PN55/2	4742	3 x Blue	-	-	-



For price, please see page 20

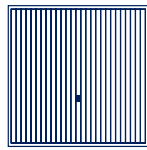

Cavendish

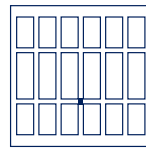

Wolsey

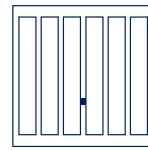

Seymour

	Spring box number	Spring box spring	No. of bands & Colour	Spring box number	Spring box spring	No. of bands & Colour	Spring box number	Spring box spring	No. of bands & Colour
7'0"x6'6"	-	-	-	PN55/2	4742	3 x Blue	PN55/2	4742	3 x Blue
7'0"x7'0"	PN55/2	4742	3 x Blue	PN155	4747	1 x Orange	PN155	4747	1 x Orange
7'5"x6'6"	PN55/2	4742	3 x Blue	PN55/2	4742	3 x Blue	PN55/2	4742	3 x Blue
7'5"x7'0"	PN55/2	4742	3 x Blue	PN155	4747	1 x Orange	PN155	4747	1 x Orange
7'6"x6'6"	PN55/2	4742	3 x Blue	PN55/2	4742	3 x Blue	PN55/2	4742	3 x Blue
7'6"x7'0"	-	-	-	PN55/2	4742	3 x Blue	PN55/2	4742	3 x Blue

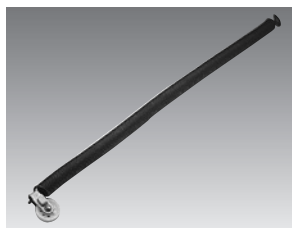

For price, please see page 20

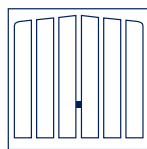

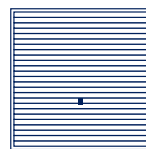

Tudor









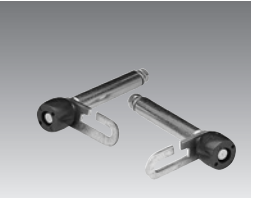

Horizontal Cedar



	Spring box number	Spring box spring	No. of bands & Colour	Spring box number	Spring box spring	No. of bands & Colour
7'0"x6'6"	PN55/2	4742	3 x Blue	PN57/1	4740	1 x Blue
7'0"x7'0"	PN155	4747	1 x Orange	PN55/2	4742	3 x Blue
7'5"x6'6"	PN55/2	4742	3 x Blue	PN57/1	4740	1 x Blue
7'5"x7'0"	PN155	4747	1 x Orange	PN150	4746	None
7'6"x6'6"	PN55/2	4742	3 x Blue	-	-	-
7'6"x7'0"	PN55/2	4742	3 x Blue	-	-	-

Mark 3C Accessories for Overhead Spring Box Pre 1999 (canopy)

				
Article	Canopy Type Cables (Overhead Spring) 6'6" (1980 mm) wide door. Sold in pairs.	Canopy Type Cables (Overhead Spring) 7'0" (2135 mm) to 8'2 1/2" (2500 mm) wide door. Sold in pairs.	Canopy Type Cables (Overhead Spring) Belgravia doors only. Sold in pairs. Pre 1999.	Rollers and spindles (pair) Overall length 94 mm. MK 3 C type only.
Ref. No.	1154	1155	1156	1158
Price £	45.00	45.00	45.00	56.00

				
Article	Rollers and spindles (pair) Overall length 81 mm. C type only.	C Type Overhead Spring For Box PN55/2. Pre 1999.	C Type Overhead Spring For Box PN56/1. Pre 1999.	C Type Overhead Spring For Box PN57/1. Pre 1999.
Ref. No.	1159	4742	4741	4740
Price £	56.00	107.00	107.00	107.00

				
Article	C Type Overhead Spring For Box PN58. Pre 1999.	C Type Overhead Spring For Box PN108. Pre 1999.	C Type Overhead Spring For Box PN115. Pre 1999.	C Type Overhead Spring For Box PN150. Pre 1999.
Ref. No.	4739	4745	4744	4746
Price £	107.00	107.00	107.00	107.00

			
Article	C Type Overhead Spring For Box PN155. Pre 1999.	C Type Overhead Spring For Box PN167. Pre 1999.	C Type Link Arm Pre 1999.
Ref. No.	4747	4743	(LH) 1202 . (RH) 1203
Price £	107.00	107.00	66.00

Framed Canopy Doors

Mark 4 / F-Type Springs - Steel Panel Doors

Used on all Framed Canopy doors pre 2002. For springs with flat fixing pins part 1197 is also required. Springs priced and supplied individually. However, it is always recommended that both springs are replaced at the same time.

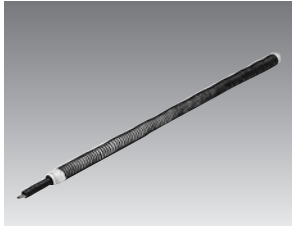

For price, please see page 25

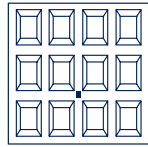

Georgian/
Georgian Elite

Spring Type

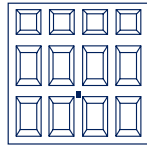

Beaumont/
Beaumont Elite

Spring Type

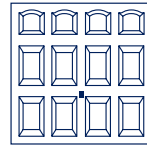

Cathedral/
Cathedral Elite

Spring Type

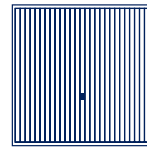

Carlton/
Carlton Elite

Spring Type

6'6"x6'3"	-	-	-	2149
6'6"x6'6"	2150	-	-	2149
6'6"x7'0"	2151	-	-	2150
7'0"x6'3"	-	-	-	2149
7'0"x6'6"	2151	2150	2150	2149
7'0"x7'0"	2153	2152	2152	2151
7'3 1/2"x6'4"	-	-	-	2149
7'5"x6'3"	-	-	-	2150
7'5"x6'6"	2151	2151	2151	2150
7'5"x7'0"	2153	2152	2152	2151
7'6"x6'6"	2151	2152	2152	2150
7'6"x7'0"	2153	2153	2153	2152
7'8 1/2"x6'3"	-	-	-	2150
7'8 1/2"x6'6 3/4"	2152	2152	2152	2150
7'8 1/2"x6'11 3/4"	2153	2152	2152	2152
8'0"x6'3"	-	-	-	2151
8'0"x6'6"	2152	2152	2152	2151
8'0"x7'0"	2153	2153	2153	2152
8'2 1/2"x6'3"	-	-	-	2151
8'2 1/2"x6'6 3/4"	-	-	-	2151
8'2 1/2"x6'11 3/4"	-	-	-	2152

Framed Canopy Doors



For price, please see page 25

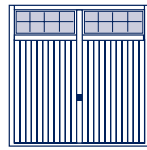

Salisbury/
SalisburyElite

Spring Type

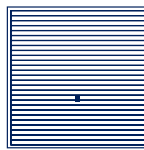

Horizon/
Horizon Elite

Spring Type

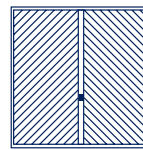

Chevron/
Chrevron Elite

Spring Type

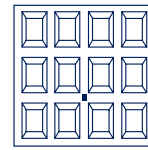

Parade
White/Brown

Spring Type

	Salisbury/ SalisburyElite	Horizon/ Horizon Elite	Chevron/ Chrevron Elite	Parade White/Brown
6'6"x6'3"	-	2149	-	-
6'6"x6'6"	-	2149	2149	-
6'6"x7'0"	-	2150	2150	-
7'0"x6'3"	-	2149	-	-
7'0"x6'6"	2151	2149	2149	2151
7'0"x7'0"	2152	2150	2150	2152
7'3 1/2"x6'4"	-	2149	-	-
7'5"x6'3"	-	2149	-	-
7'5"x6'6"	2152	2149	2150	2152
7'5"x7'0"	2153	2151	2151	2151
7'6"x6'6"	2152	2150	2150	2151
7'6"x7'0"	2153	2151	2151	2152
7'8 1/2"x6'3"	-	2150	-	-
7'8 1/2"x6'6 3/4"	-	2150	2151	-
7'8 1/2"x6'11 3/4"	-	2152	2152	-
8'0"x6'3"	-	2150	-	-
8'0"x6'6"	2153	2150	-	2151
8'0"x7'0"	2153	2152	-	2152
8'2 1/2"x6'3"	-	2150	-	-
8'2 1/2"x6'6 3/4"	-	2150	-	2152
8'2 1/2"x6'11 3/4"	-	2152	-	2153

Framed Canopy Doors

Mark 4 / F-Type Spring - GRP Premier Panel Doors

Used on all Framed Canopy doors pre 2002. For springs with flat fixing pins part S4-6 is also required. Springs priced and supplied individually. However, it is always recommended that both springs are replaced at the same time.



For price, please see page 25

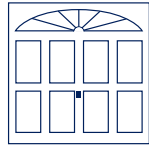

Stamford

Spring Type

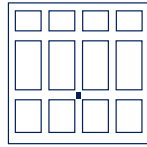

Arden

Spring Type

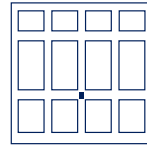

Kenmore

Spring Type

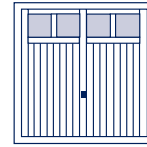

Derwent

Spring Type

7'0"x6'6"	2151	2152	2152	2152
7'0"x7'0"	2151	2152	2152	2152
7'5"x6'6"	2151	2152	2152	2152
7'6"x7'0"	2151	2152	2152	2152



For price, please see page 25

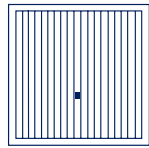

Swinton

Spring Type

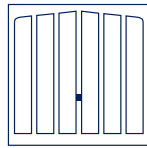

Clifton

Spring Type

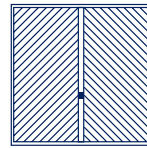

Oakham

Spring Type

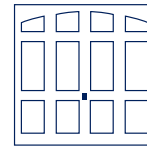

Woburn

Spring Type

7'0"x6'6"	2151	2152	2152	2152
7'0"x7'0"	2151	2152	2152	2152
7'5"x6'6"	2151	2152	2152	2152
7'6"x7'0"	2151	2152	2152	2152

Framed Canopy Doors

Mark 4 / F-Type Springs - Timber Panel Doors

Used on all Framed Canopy doors pre 2002. For springs with flat fixing pins part S4-6 is also required. Springs priced and supplied individually. However, it is always recommended that both springs are replaced at the same time.



For price, please see page 25

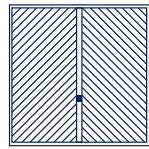

Chevron Cedar

Spring Type

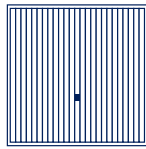

Vertical Cedar

Spring Type

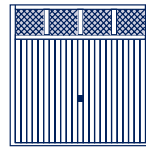

Sandhurst

Spring Type

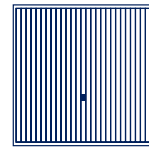

Cavendish

Spring Type

7'0"x6'6"	2150	2149	2151	2151
7'0"x7'0"	2150	2150	2152	2152
7'5"x6'6"	2150	2150	2151	2151
7'5"x7'0"	2151	2150	2152	2152
7'6"x6'6"	2150	2150	-	-
7'6"x7'0"	2151	2150	-	-



For price, please see page 25

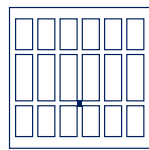

Wolsey

Spring Type

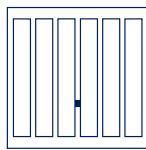

Seymour

Spring Type

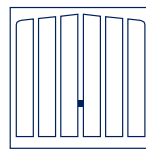

Tudor

Spring Type

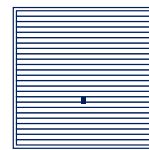







Horizontal Cedar

Spring Type

7'0"x6'6"	2150	2150	2150	2150
7'0"x7'0"	2151	2151	2151	2151
7'5"x6'6"	2151	2151	2151	2151
7'5"x7'0"	2152	2152	2152	2152
7'6"x6'6"	2151	2151	2151	-
7'6"x7'0"	2152	2152	2152	-

Accessories for Mark 4 / F-Type Doors (canopy)

				
Article	F Type Roller Spindle Assembly (Pair) E clip supplied.	Pre 2002 Framed Canopy Door Spring	Pre 2002 Framed Canopy Door Spring	Pre 2002 Framed Canopy Door Spring
Ref. No.	1160	2149	2150	2151
Price £	45.00	149.00	181.00	181.00

			
Article	Pre 2002 Framed Canopy Door Spring	Pre 2002 Framed Canopy Door Spring	Framed Canopy Link Arm Supplied with pin spacer and washer. Pre March 2002.
Ref. No.	2152	2153	(LH) 1199. (RH) 1200
Price £	181.00	197.00	66.00

Canopy Doors

C Type Side Extension Spring fitted to a timber frame - Steel Panel Doors

Used on all Canopy doors between 1999 and 2002. Springs priced and supplied individually. However, it is always recommended that both springs are replaced at the same time.



For price, please see page 30

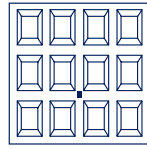

Georgian/
Georgian Elite

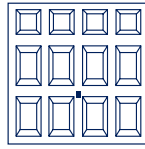

Beaumont/
Beaumont Elite

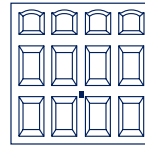

Cathedral/
Cathedral Elite

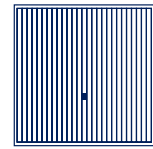

Carlton/
Carlton Elite

	Georgian/ Georgian Elite		Beaumont/ Beaumont Elite		Cathedral/ Cathedral Elite		Carlton/ Carlton Elite	
	Spring box number	No. of bands & Colour	Spring box number	No. of bands & Colour	Spring box number	No. of bands & Colour	Spring box number	No. of bands & Colour
6'6" x 6'3"	-	-	-	-	-	-	4733	White
6'6" x 6'6"	4735	Green	-	-	-	-	4733	White
6'6" x 7'0"	4737	Red	-	-	-	-	4734	2 x White
7'0" x 6'3"	-	-	-	-	-	-	4733	White
7'0" x 6'6"	4735	Green	4735	Green	4735	Green	4733	White
7'0" x 7'0"	4737	Red	4736	2 x Green	4736	2 x Green	4734	2 x White
7'3 1/2" x 6'4"	-	-	-	-	-	-	4734	2 x White
7'5" x 6'3"	-	-	-	-	-	-	4734	2 x White
7'5" x 6'6"	4736	2 x Green	4735	Green	4735	Green	4734	2 x White
7'5" x 7'0"	4737	Red	4737	Red	4737	Red	4735	Green
7'6" x 6'6"	4736	2 x Green	4736	2 x Green	4736	2 x Green	4735	Green
7'6" x 7'0"	4737	Red	4737	Red	4737	Red	4736	2 x Green
7'8 1/2" x 6'3"	-	-	-	-	-	-	4733	White
7'8 1/2" x 6'6 3/4"	4736	2 x Green	4736	2 x Green	4736	2 x Green	4734	2 x White
7'8 1/2" x 6'11 3/4"	4737	Red	4736	2 x Green	4736	2 x Green	4735	Green
8'0" x 6'3"	-	-	-	-	-	-	4735	Green
8'0" x 6'6"	4738	2 x Red	4736	2 x Green	4736	2 x Green	4736	2 x Green
8'0" x 7'0"	4738	2 x Red	4737	Red	4737	Red	4736	2 x Green
8'2 1/2" x 6'3"	-	-	-	-	-	-	4735	Green
8'2 1/2" x 6'6 3/4"	-	-	-	-	-	-	4736	2 x Green
8'2 1/2" x 6'11 3/4"	-	-	-	-	-	-	4736	2 x Green

Canopy Doors



Salisbury/
Salisbury Elite

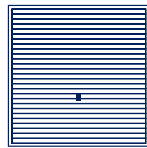

Horizon/
Horizon Elite

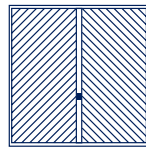

Chevron/
Chevron Elite

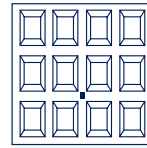

Parade
White/Brown

For price, please see page 30

	Spring box number	No. of bands & Colour	Spring box number	No. of bands & Colour	Spring box number	No. of bands & Colour	Spring box number	No. of bands & Colour
6'6"x6'3"	-	-	4733	White	-	-	-	-
6'6"x6'6"	-	-	4733	White	4733	White	-	-
6'6"x7'0"	-	-	4734	2 x White	4734	2 x White	-	-
7'0"x6'3"	-	-	4733	White	-	-	-	-
7'0"x6'6"	4735	Green	4733	White	4734	2 x White	4735	Green
7'0"x7'0"	4737	Red	4734	2 x White	4734	2 x White	4736	2 x Green
7'3 1/2"x6'4"	-	-	4733	White	-	-	-	-
7'5"x6'3"	-	-	4733	White	-	-	-	-
7'5"x6'6"	4737	Red	4733	White	4735	Green	4735	Green
7'5"x7'0"	4737	Red	4734	2 x White	4738	2 x Red	4737	Red
7'6"x6'6"	4737	Red	4735	Green	4736	2 x Green	4736	2 x Green
7'6"x7'0"	4737	Red	4735	Green	4738	2 x Red	4737	Red
7'8 1/2"x6'3"	-	-	4733	White	-	-	-	-
7'8 1/2"x6'6 3/4"	-	-	4734	2 x White	4736	2 x Green	4736	2 x Green
7'8 1/2"x6'11 3/4"	-	-	4735	Green	4738	2 x Red	4736	2 x Green
8'0"x6'3"	-	-	4735	Green	-	-	-	-
8'0"x6'6"	4737	Red	4735	Green	-	-	4736	2 x Green
8'0"x7'0"	4738	2 x Red	4735	Green	-	-	4737	Red
8'2 1/2"x6'3"	-	-	4735	Green	-	-	-	-
8'2 1/2"x6'6 3/4"	-	-	4735	Green	-	-	-	-
8'2 1/2"x6'11 3/4"	-	-	4736	2 x Green	-	-	-	-

Canopy Doors

C Type Side Extension Spring fitted to a timber frame - GRP Premier Panel Doors

Used on all Canopy doors between 1999 and 2002. Springs priced and supplied individually. However, it is always recommended that both springs are replaced at the same time.



For price, please see page 30

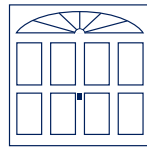

Stamford

Spring box number No. of bands & Colour

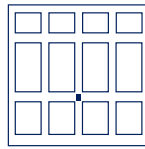

Arden

Spring box number No. of bands & Colour

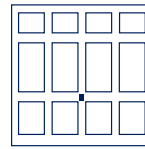

Kenmore

Spring box number No. of bands & Colour

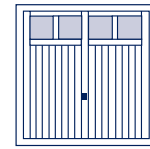

Derwent

Spring box number No. of bands & Colour

7'0"x6'6"	4734	2 x White	4734	2 x White	4734	2 x White	4734	2 x White
7'0"x7'0"	4735	Green	4735	Green	4735	Green	4735	Green
7'5"x6'6"	4734	2 x White	4734	2 x White	4734	2 x White	4734	2 x White
7'6"x7'0"	4735	Green	4735	Green	4735	Green	4735	Green



For price, please see page 30

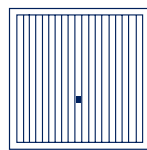

Swinton

Spring box number No. of bands & Colour

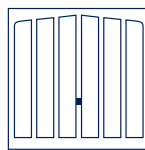

Clifton

Spring box number No. of bands & Colour

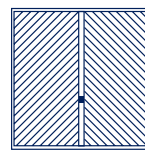

Oakham

Spring box number No. of bands & Colour

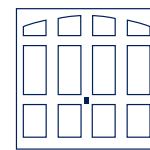

Woburn

Spring box number No. of bands & Colour

7'0"x6'6"	4734	2 x White	4734	2 x White	4734	2 x White	4734	2 x White
7'0"x7'0"	4735	Green	4735	Green	4735	Green	4735	Green
7'5"x6'6"	4734	2 x White	4734	2 x White	4734	2 x White	4734	2 x White
7'6"x7'0"	4735	Green	4735	Green	4735	Green	4735	Green

Canopy Doors

C Type Side Extension Spring fitted to a timber frame - Timber Panel Doors

Used on all Canopy doors between 1999 and 2002. Springs priced and supplied individually. However, it is always recommended that both springs are replaced at the same time.



For price, please see page 30

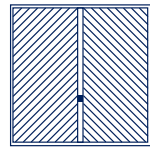

Chevron Cedar

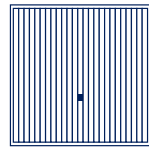

Vertical Cedar

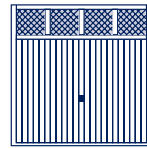

Sandhurst

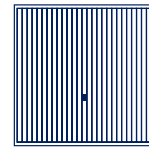

Cavendish

	Spring box number	No. of bands & Colour	Spring box number	No. of bands & Colour	Spring box number	No. of bands & Colour	Spring box number	No. of bands & Colour
7'0"x6'6"	4734	2 x White	4733	White	-	-	-	-
7'0"x7'0"	4735	Green	4734	2 x White	4736	2 x Green	4736	2 x Green
7'5"x6'6"	4735	Green	4733	White	4735	Green	4735	Green
7'5"x7'0"	4735	Green	4734	2 x White	4736	2 x Green	4736	2 x Green
7'6"x6'6"	4735	Green	4734	2 x White	4735	Green	4735	Green
7'6"x7'0"	-	-	4734	2 x White	-	-	-	-



For price, please see page 30

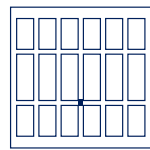

Wolsey

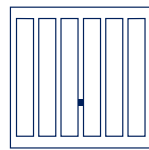

Seymour

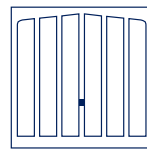

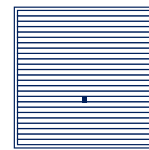

Tudor







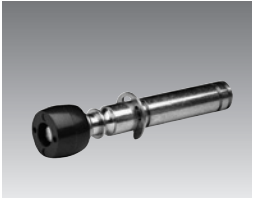

Horizontal Cedar

	Spring box number	No. of bands & Colour	Spring box number	No. of bands & Colour	Spring box number	No. of bands & Colour	Spring box number	No. of bands & Colour
7'0"x6'6"	4735	Green	4735	Green	4735	Green	N/A	N/A
7'0"x7'0"	4735	Green	4735	Green	4735	Green	N/A	N/A
7'5"x6'6"	4735	Green	4735	Green	4735	Green	N/A	N/A
7'5"x7'0"	4736	2 x Green	4736	2 x Green	4736	2 x Green	N/A	N/A
7'6"x6'6"	4735	Green	4735	Green	4735	Green	-	-
7'6"x7'0"	4736	2 x Green	4736	2 x Green	4736	2 x Green	-	-

Accessories for doors with C Type Side Extension Springs 1999 - 2002 (canopy)

				
Article	Side Extension Spring Cables Sold in pairs. 1999 - 2002.	Roller and Spindle Assembly (Pair) Side extension spring.	C Type Side Extension Spring 1999 - 2002.	C Type Side Extension Spring 1999 - 2002.
Ref. No.	1157	1161	4733	4734
Price £	45.00 (per pair)	56.00	99.00	99.00

				
Article	C Type Side Extension Spring 1999 - 2002.	C Type Side Extension Spring 1999 - 2002.	C Type Side Extension Spring 1999 - 2002.	C Type Side Extension Spring 1999 - 2002.
Ref. No.	4735	4736	4737	4738
Price £	99.00	99.00	99.00	99.00

		
Article	S Hook For canopy doors. 1999 - 2002.	Right Link Arm (bare) For canopy doors. 1999 - 2002.
Ref. No.	1194	(LH) 1204. (RH) 1205
Price £	18.00	45.00

Framed Retractable and Retractable Doors

Framed Retractable and Retractable and Double Retractable Spring - Steel Panel Doors

Used on all FR and R type doors pre 2002 (595 mm long). Springs priced and supplied individually. However, it is always recommended that both springs are replaced at the same time.



For price, please see pages 35 and 36

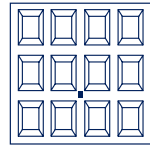

Georgian/
Georgian Elite

Spring Type

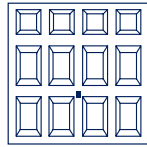

Beaumont/
Beaumont Elite

Spring Type

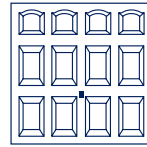

Cathedral/
Cathedral Elite

Spring Type

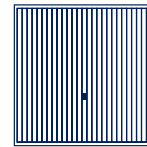

Carlton/
Carlton Elite

Spring Type

	Georgian/ Georgian Elite	Beaumont/ Beaumont Elite	Cathedral/ Cathedral Elite	Carlton/ Carlton Elite
6'6"x6'3"	-	-	-	N/A
6'6"x6'6"	4763	-	-	4776
6'6"x7'0"	4765	-	-	4777
7'0"x6'3"	-	-	-	N/A
7'0"x6'6"	4764	4763	4763	4776
7'0"x7'0"	4765	4764	4764	4763
7'3 1/2"x6'4"	-	-	-	N/A
7'5"x6'3"	-	-	-	N/A
7'5"x6'6"	4764	4764	4764	4777
7'5"x7'0"	4766	4765	4765	4766
7'6"x6'6"	4766	4764	4764	4764
7'6"x7'0"	4768	4765	4765	4766
7'8 1/2"x6'3"	-	-	-	N/A
7'8 1/2"x6'6 3/4"	4768	4766	4766	4764
7'8 1/2"x6'11 3/4"	4769	4768	4768	4764
8'0"x6'3"	-	-	-	N/A
8'0"x6'6"	4768	4766	4766	4764
8'0"x7'0"	4769	4768	4768	4767
8'2 1/2"x6'3"	-	-	-	N/A
8'2 1/2"x6'6 3/4"	-	-	-	-
8'2 1/2"x6'11 3/4"	-	-	-	-
9'0"x6'6"	4775	-	-	4769
9'0"x7'0"	4776	-	-	4769
10'0"x6'6"	4776	-	-	4774
10'0"x7'0"	4776	-	-	4775
11'0"x6'6"	4777	-	-	4775
11'0"x7'0"	4777	-	-	4776
12'0"x6'6"	4763	-	-	4776
12'0"x7'0"	4764	-	-	4777
13'0"x6'6"	4768	-	-	4764
13'0"x7'0"	4769	-	-	4766
14'0"x6'6"	4769	-	-	4766
14'0"x7'0"	4770	-	-	4768
15'0"x6'6"	-	-	-	4768
15'0"x7'0"	-	-	-	4769
16'0"x6'6"	-	-	-	4769
16'0"x7'0"	-	-	-	4770

Last three digits identification stamped onto alloy tag and or spring eye. See page 14 for spring conversion chart.

Retractable Doors

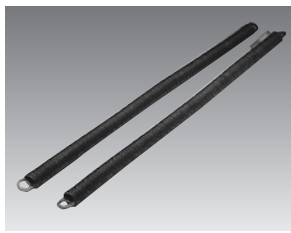

For price, please see pages 35 and 36



Salisbury/
Salisbury Elite

Spring Type

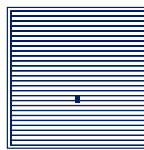

Horizon/
Horizon Elite

Spring Type

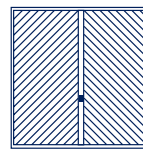

Chevron/
Chevron Elite

Spring Type

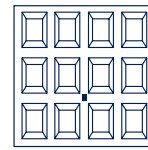

Parade
White/Brown

Spring Type

6'6"x6'3"	-	N/A	-	-
6'6"x6'6"	-	4775	4776	-
6'6"x7'0"	-	4776	4765	-
7'0"x6'3"	-	N/A	-	-
7'0"x6'6"	4764	4775	4777	4763
7'0"x7'0"	4766	4777	4764	4764
7'3 1/2"x6'4"	-	N/A	-	-
7'5"x6'3"	-	N/A	-	-
7'5"x6'6"	4768	4776	4776	4764
7'5"x7'0"	4766	4763	4763	4765
7'6"x6'6"	4766	4776	4766	4764
7'6"x7'0"	4766	4763	4768	4764
7'8 1/2"x6'3"	-	N/A	-	-
7'8 1/2"x6'6 3/4"	-	4763	4764	-
7'8 1/2"x6'11 3/4"	-	4764	4766	-
8'0"x6'3"	-	N/A	-	-
8'0"x6'6"	4766	4763	-	4766
8'0"x7'0"	4768	4764	-	4768
8'2 1/2"x6'3"	-	N/A	-	-
8'2 1/2"x6'6 3/4"	-	-	-	4766
8'2 1/2"x6'11 3/4"	-	-	-	4768
9'0"x6'6"	-	4769	-	-
9'0"x7'0"	-	4769	-	-
10'0"x6'6"	-	4769	-	-
10'0"x7'0"	-	4774	-	-
11'0"x6'6"	-	4774	-	-
11'0"x7'0"	-	4775	-	-
12'0"x6'6"	-	4775	-	-
12'0"x7'0"	-	4776	-	-
13'0"x6'6"	-	4777	-	-
13'0"x7'0"	-	4763	-	-
14'0"x6'6"	-	4764	-	4769
14'0"x7'0"	-	4766	-	4770
15'0"x6'6"	-	4766	-	-
15'0"x7'0"	-	4766	-	-
16'0"x6'6"	-	4769	-	-
16'0"x7'0"	-	4770	-	-

Last three digits identification stamped onto alloy tag and or spring eye. See page 14 for spring conversion chart.

Framed Retractable and Retractable Doors

Framed Retractable and Retractable and Double Retractable Type Spring - GRP Premier Panel Doors

Used on all FR and R type doors pre 2002. Springs priced and supplied individually.



For price, please see pages 35 and 36

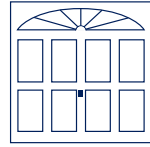

Stamford

Spring Type

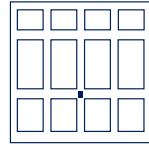

Arden

Spring Type

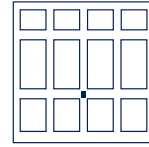

Kenmore

Spring Type

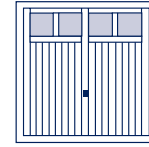

Derwent

Spring Type

7'0"x6'6"	4766	4766	4766	4766
7'0"x7'0"	4766	4766	4766	4766
7'5"x6'6"	4766	4766	4766	4766
7'6"x7'0"	4766	4766	4766	4766
9'0"x6'6"	4769	4769	4769	-
9'0"x7'0"	4769	4769	4769	-
10'0"x6'6"	4769	4769	4769	-
10'0"x7'0"	4769	4774	4774	-
11'0"x6'6"	-	4774	4774	-
11'0"x7'0"	-	4775	4775	-
12'0"x6'6"	-	4776	4776	-
12'0"x7'0"	-	4776	4776	-
14'0"x6'6"	4763	4763	4763	-



For price, please see pages 35 and 36

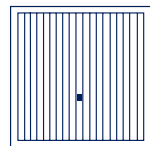

Swinton

Spring Type

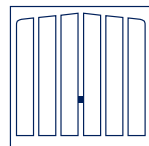

Clifton

Spring Type

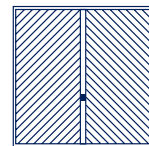

Oakham

Spring Type

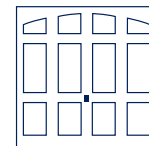

Woburn

Spring Type

7'0"x6'6"	4766	4766	4766	4766
7'0"x7'0"	4766	4766	4766	4766
7'5"x6'6"	4766	4766	4766	4766
7'6"x7'0"	4766	4766	4766	4766
9'0"x6'6"	-	4769	-	-
9'0"x7'0"	-	4769	-	-
10'0"x6'6"	-	4769	-	-
10'0"x7'0"	-	4774	-	-
11'0"x6'6"	-	-	-	-
11'0"x7'0"	-	-	-	-
12'0"x6'6"	-	-	-	-
12'0"x7'0"	-	-	-	-
14'0"x6'6"	-	4763	-	-

Last three digits identification stamped onto alloy tag and or spring eye. See page 14 for spring conversion chart.

Framed Retractable and Retractable Doors

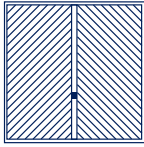
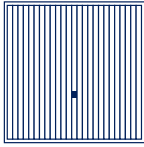
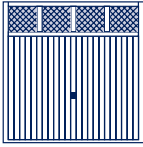
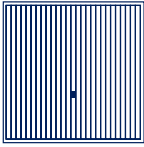

Framed Retractable and Retractable and Double Retractable Type Spring - Timber Panel Doors
 Used on all FR and R type doors pre 2002. Springs priced and supplied individually.

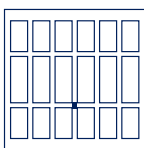
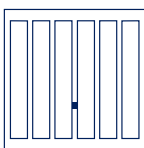
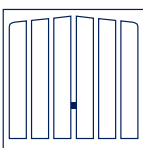
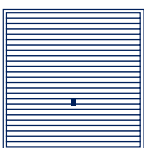



 <p>For price, please see pages 35 and 36</p>	 <p>Chevron Cedar</p> <p>Spring Type</p>	 <p>Vertical Cedar</p> <p>Spring Type</p>	 <p>Sandhurst</p> <p>Spring Type</p>	 <p>Cavendish</p> <p>Spring Type</p>
	7'0"x6'6"	4763	4775	-
7'0"x7'0"	4764	4775	4766	4766
7'5"x6'6"	4764	4776	4764	4764
7'5"x7'0"	4766	4763	4766	4766
7'6"x6'6"	4764	4763	4764	4764
7'6"x7'0"	4764	4763	-	-
14'0"x6'6"	-	4768	4766	4766
14'0"x7'0"	-	4768	4768	4768

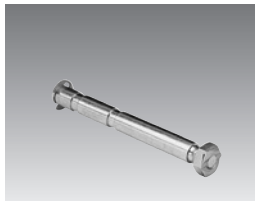
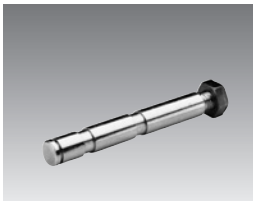



 <p>For price, please see pages 35 and 36</p>	 <p>Wolsey</p> <p>Spring Type</p>	 <p>Seymour</p> <p>Spring Type</p>	 <p>Tudor</p> <p>Spring Type</p>	 <p>Horizontal Cedar</p> <p>Spring Type</p>
	7'0"x6'6"	4764	4764	4764
7'0"x7'0"	4764	4764	4764	N/A
7'5"x6'6"	4764	4764	4764	N/A
7'5"x7'0"	4766	4766	4766	N/A
7'6"x6'6"	4764	4764	4764	-
7'6"x7'0"	4766	4766	4766	-
14'0"x6'6"	4763	4763	4763	-
14'0"x7'0"	4764	4764	4764	-



Last three digits identification stamped onto alloy tag and or spring eye. See page 14 for spring conversion chart.

Single and Double Retractable Gear Components

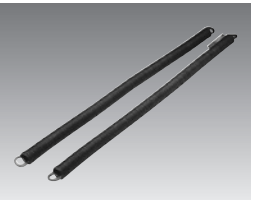
				
Article	Spring Anchor Pin E-clip supplied suitable for DC/DR/FR/R. Sold individually.	Spring Anchor Pin Suitable for R/FR/DR from 1988 to 2002.	Single. Double and Framed Retractable Door Spring - 595 mm Sold individually. Pre 2002.	Single. Double and Framed Retractable Door Spring - 595 mm Sold individually. Pre 2002.
Ref. No.	1211	1214	4762	4763
Price £	26.00	22.00	134.00	134.00



				
Article	Single. Double and Framed Retractable Door Spring - 595 mm Sold individually. Pre 2002.	Single. Double and Framed Retractable Door Spring - 595 mm Sold individually. Pre 2002.	Single. Double and Framed Retractable Door Spring - 595 mm Sold individually. Pre 2002.	Single. Double and Framed Retractable Door Spring - 595 mm Sold individually. Pre 2002.
Ref. No.	4764	4765	4766	4768
Price £	134.00	134.00	134.00	134.00

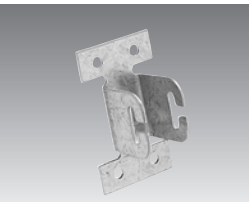



				
Article	Single. Double and Framed Retractable Door Spring - 595 mm Sold individually. Pre 2002.	Single. Double and Framed Retractable Door Spring - 595 mm Sold individually. Pre 2002.	Single. Double and Framed Retractable Door Spring - 595 mm Sold individually. Pre 2002.	Single. Double and Framed Retractable Door Spring - 595 mm Sold individually. Pre 2002.
Ref. No.	4769	4770	4774	4775
Price £	134.00	134.00	134.00	134.00

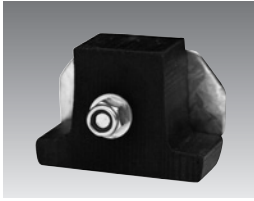

			
Article	Single. Double and Framed Retractable Door Spring - 595 mm Sold individually. Pre 2002.	Single. Double and Framed Retractable Door Spring - 595 mm Sold individually. Pre 2002.	Spring Anchor Bracket From 1988 - 2002.
Ref. No.	4776	4777	345
Price £	134.00	134.00	24.00

For retractable door spring, last three digits identification stamped onto alloy tag and or spring eye. See page 14 for spring conversion chart.

Double Canopy Doors

				
Article	Rubber stop DC type only from 1992.	Double Canopy Door Spring - 685 mm Sold individually. Pre 2002.	Double Canopy Door Spring - 685 mm Sold individually. Pre 2002.	Double Canopy Door Spring - 685 mm Sold individually. Pre 2002.
Ref. No.	1213	4773	4748	4749
Price £	26.00	134.00	134.00	134.00

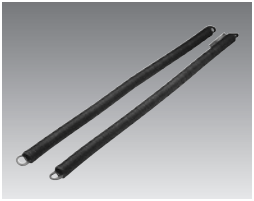
				
Article	Double Canopy Door Spring - 685 mm Sold individually. Pre 2002.	Double Canopy Door Spring - 685 mm Sold individually. Pre 2002.	Double Canopy Door Spring - 685 mm Sold individually. Pre 2002.	Double Canopy Door Spring - 685 mm Sold individually. Pre 2002.
Ref. No.	4750	4751	4752	4753
Price £	134.00	134.00	134.00	134.00

				
Article	Double Canopy Door Spring - 685 mm Sold individually. Pre 2002.	Double Canopy Door Spring - 685 mm Sold individually. Pre 2002.	Double Canopy Door Spring - 685 mm Sold individually. Pre 2002.	Double Canopy Door Spring - 685 mm Sold individually. Pre 2002.
Ref. No.	4754	4755	4756	4757
Price £	134.00	134.00	134.00	134.00

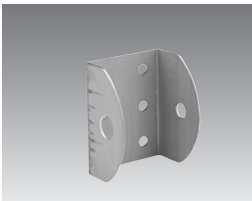
		
Article	Double Canopy Door Spring - 685 mm Sold individually. Pre 2002.	Roller Bracket (on door) Suitable for DC/DR from 1988 to 2002.
Ref. No.	4758	344
Price £	134.00	19.00

For retractable door spring, last three digits identification stamped onto alloy tag and or spring eye. See page 14 for spring conversion chart.

Double Canopy Doors

Double Canopy Type Spring - Steel Panel Doors

Used on all DC and DR type doors pre 2002 (685 mm long).

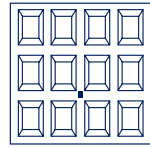

Georgian

DC Spring

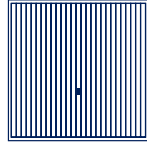

Carlton

DC Spring

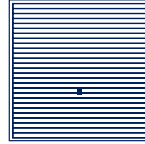

Horizon

DC Spring

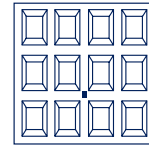

Parade White/Brwon

DC Spring

For price, please see page 36

9'0"x6'6"	4755	4754	4752	-
9'0"x7'0"	4756	4754	4754	-
10'0"x6'6"	4756	4754	4752	-
10'0"x7'0"	4756	4756	4754	-
11'0"x6'6"	4756	4755	4754	-
11'0"x7'0"	4757	4757	4756	-
12'0"x6'6"	4758	4756	4755	-
12'0"x7'0"	4758	4758	4757	-
13'0"x6'6"	4750	4758	4757	-
13'0"x7'0"	4752	4749	4758	-
14'0"x6'6"	4751	4748	4758	4753
14'0"x7'0"	4753	4750	4758	4754
15'0"x6'6"	-	4758	4758	-
15'0"x7'0"	-	4752	4750	-
16'0"x6'6"	-	4751	4750	-
16'0"x7'0"	-	4753	4752	-

Double doors not sold as Elite.

Last three digits identification stamped onto alloy tag and or spring eye. See page 14 for spring conversion chart.

Double Canopy type Doors

Double Canopy Type Spring - GRP Premier Panel Doors

Used on all DC and DR type doors pre 2002.



For price, please see page 36

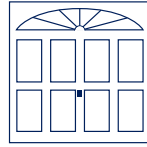

Stamford

DC Spring

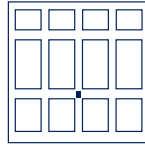

Arden

DC Spring

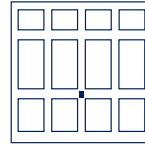

Kenmore

DC Spring

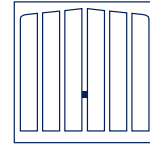

Clifton

DC Spring

9'0"x6'6"	4750	4750	4750	4750
9'0"x7'0"	4753	4753	4753	4753
10'0"x6'6"	4753	4753	4753	4753
10'0"x7'0"	4755	4755	4755	4755
11'0"x6'6"	-	4754	4754	-
11'0"x7'0"	-	4756	4756	-
12'0"x6'6"	-	4755	4755	-
12'0"x7'0"	-	4757	4757	-
14'0"x6'6"	4757	4757	4757	4757

Double Canopy Type Spring - Timber Panel Doors

Used on all DC and DR type doors pre 2002.



For price, please see page 36

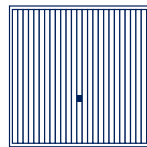

Vertical Cedar

DC Spring

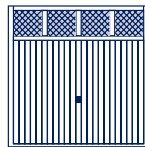

Sandhurst

DC Spring

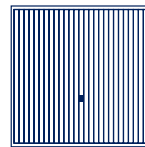

Cavendish

DC Spring

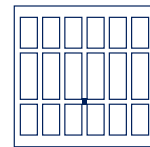

Wolsey

DC Spring

14'0"x6'6"	4748	4751	4751	4748
14'0"x7'0"	4748	4750	4750	4749

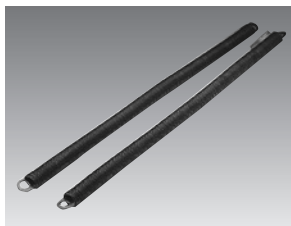

For price, please see page 36

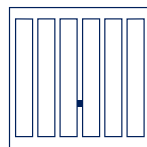

Seymour

DC Spring

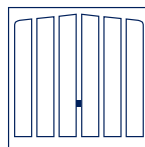



Tudor





DC Spring

14'0"x6'6"	4748	4748
14'0"x7'0"	4749	4749

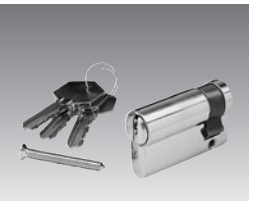
Last three digits identification stamped onto alloy tag and or spring eye. See page 14 for spring conversion chart.

Handles, Lock Assemblies and Keys

				
Article	ZA Series Locks Includes keys, washers, nuts and bolts. Back face - ZA0001-ZA0200. Supplied with 2 keys.	ZA Series Keys Key numbers between: ZA/0001 - ZA/0200. Supplied with 2 keys.	92 Series Keys Key numbers between: 92/201 - 92/400. Supplied with 2 keys.	Lock Barrel (1992 - 1998) Length 40 mm. For steel doors. Supplied with 2 keys.
Ref. No.	1164	1162	1163	1165
Price £	74.00	19.00	19.00	45.00

				
Article	Lock Barrel (1992 - 1998) Length 50 mm. T&G Timber. Supplied with 2 keys.	Single Door Brass Handle 1998 - April 2002.	Handle Conversion Kit Includes 2 keys, washer, plastic cups, screws, counterplates, plastic crank, slit bolt and nut.	T- Handle Assembly Includes 2 keys, washer, slit bolt and nut, plastic cups and screws. Key no. between 201 and 400.
Ref. No.	1166	1183	1171	1191
Price £	56.00	53.00	114.00	102.00

	
Article	Handle Repair Kit DR/DC type only up to Dec. 1993 (latch cable only).
Ref. No.	1170
Price £	38.00



Garage Side Doors

				
Article	Black Lever/ Knob Handle Side Hinged Doors	Black Lever/ Lever Handle Side Hinged Doors	White Lever/ Lever Handle Side Hinged Doors	Chrome Effect Lever/ Lever Handle Side Hinged Doors
Ref. No.	3348	6152	3349	3351
Price £	44.00	48.00	166.00	207.00

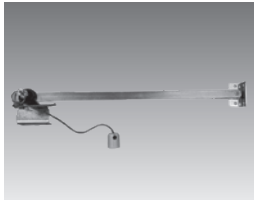
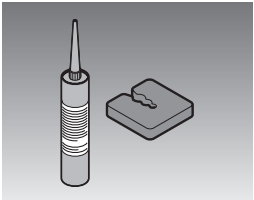

				
Article	Shoot Bolt For side hinged door. 2002 - 2021.	Cylinder for Side Hinged steel doors Supplied with 3 keys.	Cylinder for Side Hinged timber doors	Lock Body 2002 - current.
Ref. No.	395	393	6112	390
Price £	42.00	59.00	59.00	71.00

		
Article	Door Stay	Compensation Kit for Side-Hinged garage doors 2021 onwards.
Ref. No.	8264	8261
Price £	67.00	174.00

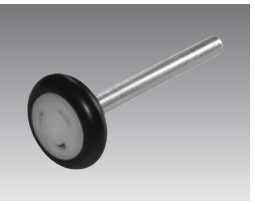
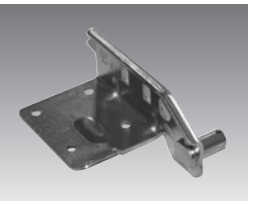
Springs and Brackets

				
Article	Bottom Roller Bracket Tension Track Right Version	Bottom Roller Bracket Tension Track Left Version	110 mm Bottom Roller Tension Track	Bottom Roller Bracket Torsion/Torsion Low Headroom Track Right Version
Ref. No.	1876	5103	5360	3361
Price £	19.00	19.00	23.00	25.00

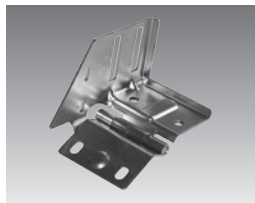

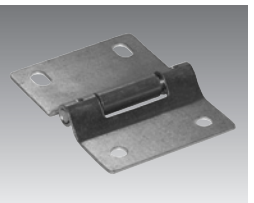
				
Article	Bottom Roller Bracket Torsion/Torsion Low Headroom Track Left Version	Pin and Spacer Torsion/Torsion Low Headroom Track	50 mm Bottom Roller Torsion/Torsion Low Headroom Track	Intermediate Roller Bracket Tension, Torsion and Torsion Low Headroom Track Right Version
Ref. No.	3362	3364	3363	3358
Price £	25.00	15.00	17.00	24.00

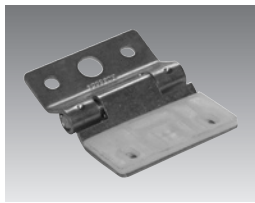
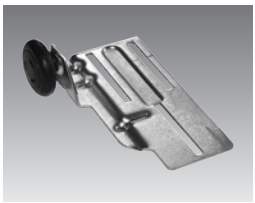
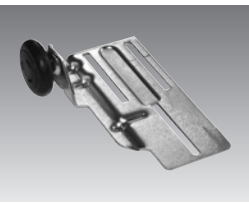

				
Article	Intermediate Roller Bracket Tension, Torsion and Torsion Low Headroom Track Left Version	Roller Holder	40 mm Intermediate Roller Tension, Torsion and Torsion Low Headroom Track	Intermediate Panel Hinge (not for LTH or Wicket Door)
Ref. No.	3359	5570	3365	3360
Price £	24.00	17.00	18.00	17.00

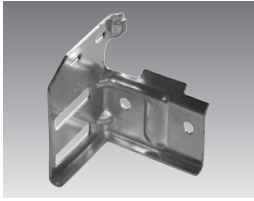
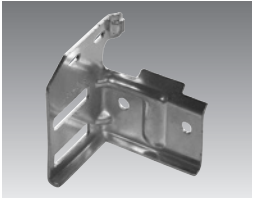
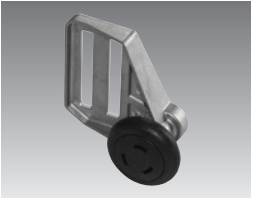
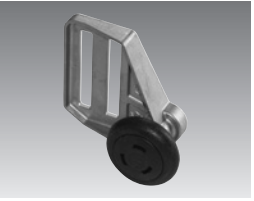
			
Article	Intermediate Panel Hinge (LTH only)	Top Roller Bracket and Roller Tension Track Right Version	Top Roller Bracket and Roller Tension Track Left Version
Ref. No.	7096	2629	2749
Price £	18.00	25.00	25.00

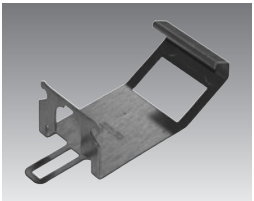
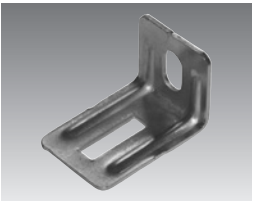
Springs and Brackets

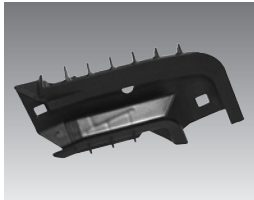
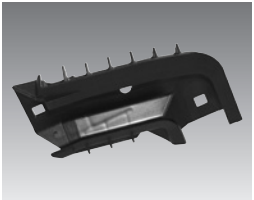

				
Article	Top Roller Bracket Torsion Track Right Version	Top Roller Bracket Torsion Track Left Version	Top Holder and Roller Torsion Track Right Version	Top Holder and Roller Torsion Track Left Version
Ref. No.	3356	3357	3354	3355
Price £	27.00	27.00	36.00	36.00

				
Article	Top Roller Bracket and Roller Low Headroom Torsion Track	Horizontal Track Support Bracket	Frame Fixing Bracket Tension, Torsion and Torsion Low Headroom Track	Buffer Spring Tension and Torsion Low Headroom Track
Ref. No.	1587	7098	7099	7100
Price £	25.00	15.00	13.00	23.00

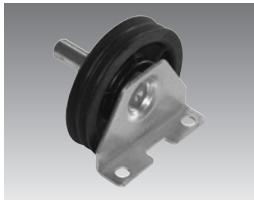

				
Article	Guide Curve Tension and Torsion Low Headroom Track Right Version	Guide Curve Tension and Torsion Low Headroom Track Left Version	Travel Limit Assembly Tension Track	Cable Clasp Tension Track (incl. shouldered fixing)
Ref. No.	5254	5255	1880	4063
Price £	36.00	36.00	18.00	19.00

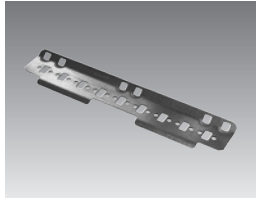
	
Article	Cable Support Bracket and Pulley Tension Track
Ref. No.	4065
Price £	26.00

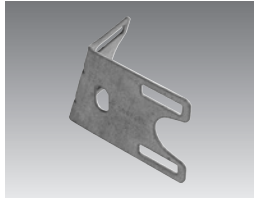

Springs and Brackets

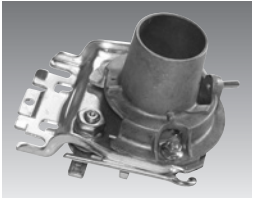
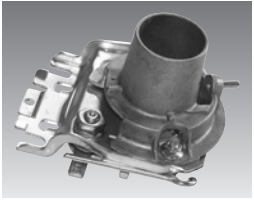
			
Article	Spring Tension Plate Tension Track	Shaft Support Holder Torsion Track	Shaft Support Bracket Torsion Track
Ref. No.	4064	7101	7102
Price £	16.00	19.00	18.00

Cones and Drums

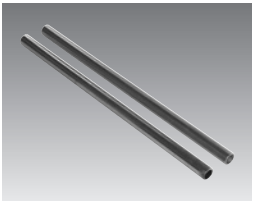
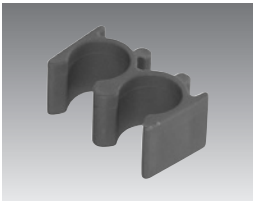
				
Article	Shaft Coupling Torsion/Torsion Low Headroom Track	Spring Safety Device with Cone Seat Torsion/Torsion Low Headroom Track Right Version	Spring Safety Device with Cone Seat Torsion/Torsion Low Headroom Track Left Version	Adapter for Spring Safety Device Torsion/Torsion Low Headroom Track
Ref. No.	5572	7104	5573	5574
Price £	42.00	128.00	128.00	12.00

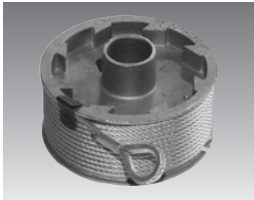
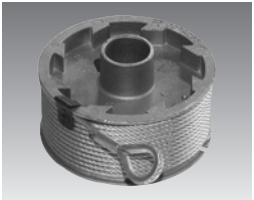
			
Article	Spring Tensioning Cone Torsion/Torsion Low Headroom Track	Tensioning Spindle Torsion/Torsion Low Headroom Track	Tensioning Spindle Clamp Torsion/Torsion Low Headroom Track
Ref. No.	7105	7106	7107
Price £	46.00	19.00 (per pair)	12.00

				
Article	Cable Drum (\leq 2250 mm) Torsion/Torsion Low Headroom Track Right Version	Cable Drum (\leq 2250 mm) Torsion/Torsion Low Headroom Track Left Version	Cable Drum ($>$ 2250 mm) Torsion/Torsion Low Headroom Track Right Version	Cable Drum ($>$ 2250 mm) Torsion/Torsion Low Headroom Track Left Version
Ref. No.	7108	7109	7110	7111
Price £	89.00	89.00	103.00	103.00

	
Article	Pulley Cover Tension Track
Ref. No.	7123
Price £	15.00

Tension Spring Assembly

	Article	Ref. No.	Price £
	Tension Spring Assembly Tension Track		
	Type 1, No. 751	7124	200.00
	Type 1, No. 752	7125	203.00
	Type 1, No. 753	5219	176.00
	Type 1, No. 754	6497	180.00
	Type 2, No. 756	4968	272.00
	Type 2, No. 757	7126	323.00
	Type 1, No. 761	6608	228.00
	Type 1, No. 762	3295	230.00
	Type 1, No. 763	7127	239.00
	Type 1, No. 764	6691	200.00
	Type 1, No. 765	7128	251.00
	Type 2, No. 766	7129	303.00
	Type 1, No. 772	7130	272.00
	Type 2, No. 776	7131	335.00
	Type 2, No. 777	7132	345.00
	Type 2, No. 786	6823	326.00

Torsion Spring Assembly



Article	Ref. No.	Price £
Torsion Spring Assembly Torsion and Low Headroom Torsion Track		
No. R700	7133	216.00
No. L700	8048	216.00
No. R701	7134	202.00
No. L701	6550	202.00
No. R702	6370	173.00
No. L702	7135	209.00
No. R703	7136	209.00
No. L703	6597	173.00
No. R704	7137	200.00
No. L704	6979	200.00
No. R705	7138	274.00
No. L705	6707	274.00
No. R707	7139	338.00
No. L707	6314	274.00
No. L709	6107	411.00
No. R723	7140	248.00
No. L723	7141	248.00

Lifting Cables



	Article	Ref. No.	Price £
Lifting cable ø 3 mm Tension Track			
	L = 2365 mm, Door Height 1875 mm	7472	111.00
	L = 2445 mm, Door Height 1955 mm	-	111.00
	L = 2490 mm, Door Height 2000 mm	4728	111.00
	L = 2570 mm, Door Height 2080 mm	-	111.00
	L = 2615 mm, Door Height 2125 mm	3962	116.00
	L = 2695 mm, Door Height 2205 mm	6890	116.00
	L = 2740 mm, Door Height 2250 mm	7142	116.00
	L = 2865 mm, Door Height 2375 mm	7143	116.00
	L = 2990 mm, Door Height 2500 mm	7144	116.00
	L = 3115 mm, Door Height 2625 mm	-	116.00
Lifting cable ø 3 mm Torsion Track			
	L = 3040 mm, Door Height ≤ 2250 mm	4047	44.00
	L = 3780 mm, Door Height >2250 mm	6467	50.00
Lifting cable ø 3 mm Low Headroom Torsion Track			
	L = 5280 mm, Door Height ≤ 2065 mm	7145	111.00
	L = 5475 mm, Door Height ≤ 2190 mm	6763	123.00
	L = 5600 mm, Door Height ≤ 2240 mm	-	121.00
	L = 5655 mm, Door Height ≤ 2250 mm	7146	121.00
	L = 6250 mm, Door Height ≤ 2490 mm	7147	121.00
	L = 6900 mm, Door Height ≤ 2830 mm	-	131.00
	L = 7300 mm, Door Height ≤ 3000 mm	-	139.00

Frame Fitting Packs

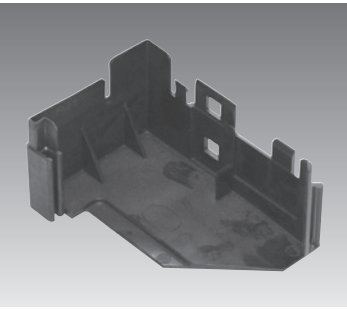
	Article	Ref. No.	Price £
	Frame Leg Shoe Tension, Torsion and Low Headroom Torsion Track		
	Right Version	7148	19.00
	Left Version	7149	19.00

	Article	Article No.	Brain No.	Price £
	Frame Fitting Pack Z-Track			
	Door Height 2000 mm	3053105	729	432.00
	Door Height 2125 mm	3053104	730	445.00
	Door Height 2250 mm	3053103	1099	460.00
	Frame Fitting Pack N-Track			
	Door Height 2000 mm	3047468	732	432.00
	Door Height 2125 mm	3047467	733	445.00
	Door Height 2250 mm	3047466	734	460.00
	Frame Fitting Pack L-Track			
	Door Height 2000 mm	3047479	742	610.00
	Door Height 2125 mm	3047478	743	624.00
	Door Height 2250 mm	3047477	744	639.00

Seals and Profiles

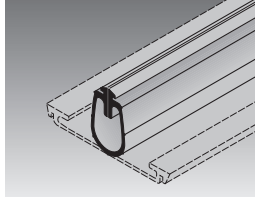
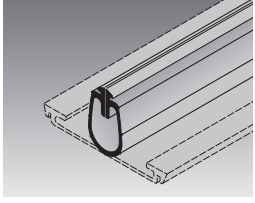
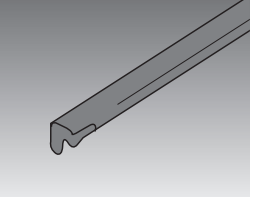
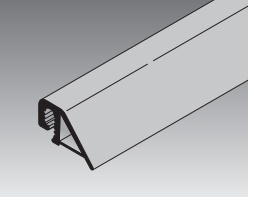
				
Article	Bottom seal 3 metre length	Bottom seal 5.5 metre length	Frame side seal 3 metre length	Fascia seal
Ref. No.	8454	8455	8453	6234
Price £	171.00	334.00	36.00	23.00

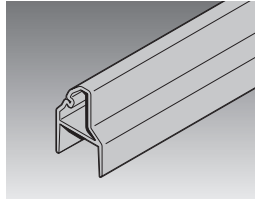
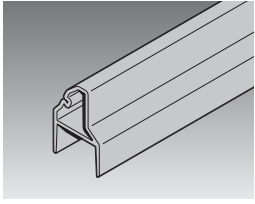
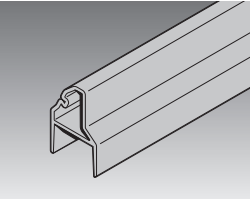
			
Article	Shortening profile metre length	Shortening profile metre length	Shortening profile metre length
Ref. No.	6792	8763	8764
Price £	60.00	91.00	107.00

GaraMatic Operators



Article	5 Button Hand Transmitter (Gloss Black) 868 mHz bi-directional	5 Button Hand Transmitter (Matt Black) 868 mHz bi-directional	5 Button Hand Transmitter (Gloss White) 868 mHz bi-directional	4 Button Hand Transmitter (Matt Black) 868 mHz bi-directional
Ref. No.	6714	7471	6713	6779
Price £	94.00	93.00	94.00	76.00

Article	1 Button Hand Transmitter (Gloss Black) 868 mHz bi-directional	HSE Hand Transmitter Cover	Hand Transmitter Station Gloss Black Gloss White	Hand Transmitter Sun Visor / Wall Holder
Ref. No.	6710	8977	6719 6720	6784
Price £	80.00		each 15.00	14.00

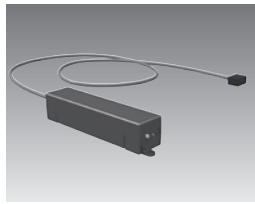
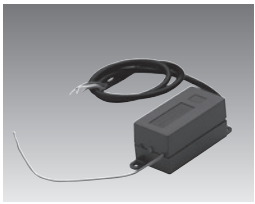

Article	4 Button Hand Transmitter Matt Black 868 mHz bi-directional	2 Button Hand Transmitter (Gloss Green) 868 mHz bi-directional	1 Button Transmitter For car cigarette lighter bi-directional	2 Button Transmitter For car cigarette lighter bi-directional
Ref. No.	7470	6965	6782	6783
Price £	73.00	105.00	73.00	73.00

Article	HS4 Blue buttons 868 mHz	HSM4 Grey buttons 40 mHz	HSE2 Grey buttons 40 mHz	Robust 3-channel (Bi-directional) hand transmitter
Ref. No.	680	676	677	8880
Price £	80.00	80.00	80.00	108.00

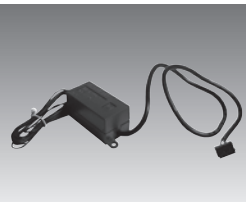
GaraMatic Operators

				
Article	HE3 Internal Receiver 868 mHz bi-directional (not to be used outside)	Radio Receiver Blue button 868 mHz (white aerial lead)	External receiver HER 1-BS	Radio Receiver Grey button 40 mHz
Ref. No.	6785	690	6715	685
Price £	150.00	122.00	272.00	110.00

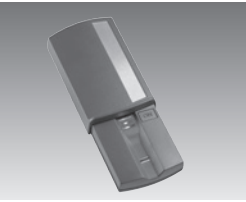

				
Article	IT1 Wired Internal Push Button	IT1 B Wired Illuminated Push Button	IT3B Wired Wall Console	FIT2 Wireless Wall Console 868 mHz bi-directional
Ref. No.	695	2875	8733	6718
Price £	34.00	49.00	52.00	109.00



				
Article	Series 4 External Bluetooth Antenna to increase signal range	FCT10 Wireless Code Switch (slide lid) 868 mHz bi-directional	FCT3 Wireless Code Switch 868 mHz bi-directional	FFL12 Bisecur Wireless Finger Scanner (with lid)
Ref. No.	8128	6716	6717	6796
Price £	107.00	212.00	141.00	281.00

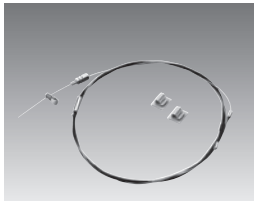

Please note: GaraMatic Series 3 handsets can be downgraded to work on 868 mHz blue button handsets (HS4, HSM4, HSE2).

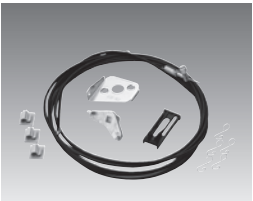
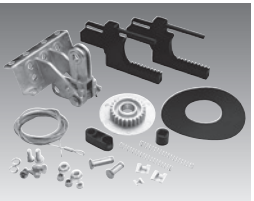
GaraMatic Operators

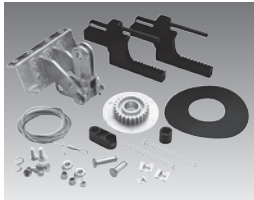
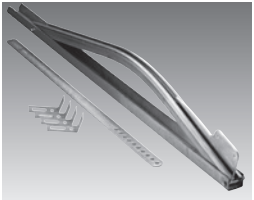

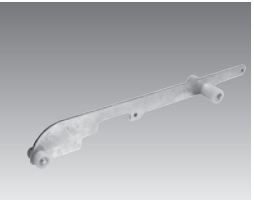

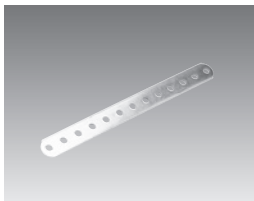
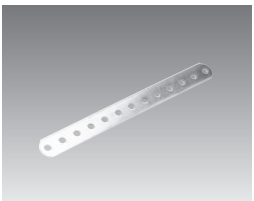
				
Article	ESA40 Face-Fixed Key Switch	ESU40 Recessed Key Switch	EL101 Internal Light Beam Device	EL301N Light Beam Device
Ref. No.	2876	2877	6786	2884
Price £	73.00	103.00	103.00	170.00

				
Article	Emergency Release For retractable doors with lock and handle	Emergency Release Canopy doors or sectional doors without handles	Emergency Release For sectional doors with lock and handle	Delatching Kit For N800 double retractable doors (437.197)
Ref. No.	704	703	702	2643
Price £	47.00	65.00	66.00	116.00

				
Article	Delatching Kit For N80 single retractable doors (437.195)	Bow Arm For canopy doors	Bow Arm Connection	Canopy Extension Bracket
Ref. No.	705	708	4917	709
Price £	71.00	141.00	51.00	65.00

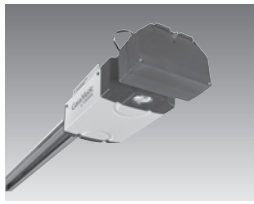

				
Article	Extended Towing Arm 258 mm long	Extended Towing Arm 495 mm long	Reinforcing Kit For sectional doors. Recommended for heavy sectional doors	Extended Towing Arm 270 mm long
Ref. No.	2482	2628	712	711
Price £	24.00	49.00	70.00	36.00

GaraMatic Operators

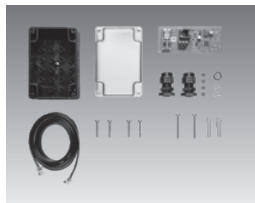
				
Article	Series 3 Options Relay (GaraMatic 10 and 20 add-on)	Series 3 Options Relay (GaraMatic 7 and 9 add-on)	Series 2 and Series 3 HNA 18-3 Battery Backup For GaraMatic Operators	Key Ring
Ref. No.	3072	5295	5500	4877
Price £	53.00	53.00	274.00	9.00

	
Article	Options relay for control of garage light, warning light or limit switch report HOR-HCP
Ref. No.	8125
Price £	71.00

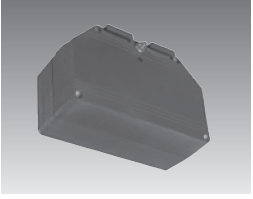
GaraMatic Operators (Series 4)

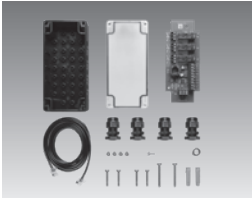



				
Article	Series 4 Options Relay	Emergency accumulator (for Series 4 operators)	Series 4 External Bluetooth receiver (GaraMatic 9 add-on)	Series 4 External Bluetooth Antenna to increase signal range
Ref. No.	8125	8126	8129	8128
Price £	75.00	263.00	171.00	122.00
				
Article	Series 4 Universal Adapter Print for control of operator light, partial open and ventilation position UAP-1-HCP			
Ref. No.	8421			
Price £	137.00			



EuroPro

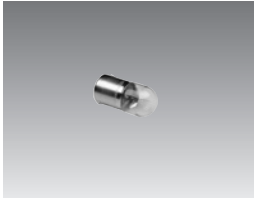

Article	GaraGlide / Euro Pro Hand Transmitter Sold individually	Eco Star Hand Transmitter 433 mHz RSC2 remote hand transmitter for Euro Pro operator
Ref. No.	6251	7315
Price £	97.00	79.00

Bulbs and Batteries

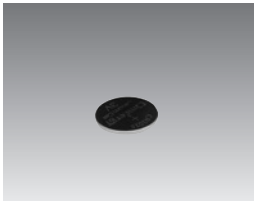
				
Article	Bulb Suitable for GaraMatic 7 and 9 operators Auto Expert	Bulb Suitable for GaraMatic 10 and 20 operators	LED Bulb Suitable for GaraMatic 9 operator	LED Bulb Suitable for GaraMatic 10 and 20 operators
Ref. No.	715	4643	7807	7806
Price £	16.00	19.00	23.00	23.00

			
Article	CR2032 Battery Suitable for wall consoles etc.	A11 Battery Suitable for HSE2 hand transmitter	A23 Battery Suitable for HS2. HSM2. HS4 and HSM4
Ref. No.	4644	2521	2522
Price £	18.00	18.00	18.00

Touch Up Paint



Aerosol Spray
£ 50.00 ea.



Touch up Pot
£ 14.00 ea.

	Ref. No.	Ref. No.
Burgundy Brown	6851	5387
Golden Brown	6852	3258
Light Ivory (RAL 1015)	7521	7177
Ruby Red (RAL 3003)	6821	2740
Signal Blue (RAL 5005)	6822	2742
Steel Blue (RAL 5011)	6819	3256
Pigeon Blue (RAL 5014)	-	7178
Moss Green (RAL 6005)	6837	2743
Fir Green (RAL 6009)	7328	7180
Anthracite Grey (RAL 7016)	7333	7179
Stone Grey (RAL 7030)	7332	7181
Light Grey (RAL 7035)	7330	7182
Window Grey (RAL 7040)	7329	7183
Clay Brown (RAL 8003)	7335	7185
Terra Brown (RAL 8028)	6818	3255
Jet Black (RAL 9005)	6817	2741
Traffic White (RAL 9016)	6820	3254
Chartwell Green (BS 4800)	7784	7771
Slate Grey (RAL 7015)	-	7907

Warranty

Garador products are manufactured to the highest quality standards and leave our factory only after rigorous quality testing. However, if you should have grounds for complaint, this section tells you what our door warranty offers, and how to go about making your claim.

Warranty Period

The purchaser is granted a warranty covering the safe and reliable function of the Garador garage door for a period of 10 years from the date of purchase. A 5 year warranty applies to springs, wire cables, track rollers, hinges and guide rollers. The warranty period for replacement parts is 12 months or to the end of your existing warranty period on the door, whichever is longer.

In the case of foil-coated timber effect and PVC doors, a warranty of 5 years is granted, for timber and GRP doors a warranty of 2 years is granted on the door panels alone under the terms and conditions specified herein. The door mechanism and steel frame (if applicable) is covered by the 10 year warranty period.

Performance

During the warranty period we will replace any and all defective parts which can be proved to be attributed to a material or manufacturing fault. We do not accept costs for dismantling and installation nor for carriage.

Requirements

Warranty claims are only applicable in the country where the parts are purchased. The parts must have been purchased through our authorised distribution channels. The warranty only covers damage to the contract object.

Garador Installers

Installing of replacement parts can be dangerous and lead to further problems. We would always recommend installation of any replacement part to be carried out by a Recommended Garador Installer. For further details please call us on 01935 443722 or refer to the Garador website.

GARADOR

The Garage Door People

Bunford Lane, Yeovil, Somerset, BA20 2GL
Tel: (01935) 443722 Fax: (01935) 443744

www.garador.co.uk



Garador is the UK's leading manufacturer of garage doors and operators, with an ultra-modern production facility located in Somerset. We use German engineering expertise to produce highly sophisticated doors and operators. By purchasing a Garador product you can be assured of the highest level of quality, safety and security. With a nationwide network of stockists, installers and service technicians we are an ideal partner for your project.