

Rollixo RTS

Quick Commissioning Guide XSE

HOME MOTION by

somfy[®]

CONTENTS

Rollixo RTS Solutions	Page 3
Rollixo RTS Control Panel Overview	Page 4
Rollixo RTS Control Panel Mounting	Page 4
Somfy RDO Motor Wiring	Page 4
Safety Brake Wiring & Powering Up Rollixo RTS	Page 5
Somfy RDO Motor Direction of Rotation Setting	Page 6
Somfy RDO Motor Limit Setting	Page 7
OSE Safety Edge Transmitter Pairing & Testing	Page 8
Pairing Keygo RTS keyfob's	Page 8
Positioning of Magnets	Page 9
Locking out the Panel	Page 9
Deleting Controls/Transmitters	Page 10
Complete Check List	Page 11
XSE transmitter – Installation instructions.....	Page 12

More information from fitters guides to marketing brochures and videos

Please visit www.Rollixo.co.uk

Rollixo RTS Solutions

This quick guide provides basic installation and commissioning guidance based on the Somfy Rollixo RTS controller and safety edge solutions. Refer to the main Rollixo RTS controller and wireless safety edge installation guides where more in-depth information relating to the installation procedure of the Rollixo RTS system is required.

Rollixo RTS Safety Edge Solutions

There are two Somfy wireless safety edge solutions available with the Rollixo RTS:

Rollixo RTS ESE – ESE stands for 'Electrical Safety Edge' (sometimes referred to as a resistive safety edge).

This kit is supplied with a safety edge transmitter and is connected to a Somfy RF Welded electrical safety edge. The RF Welded electrical safety edge consists of two metal strips running through the safety edge, which come into contact once the safety edge is depressed. This in turn results in a signal from the safety edge transmitter, indicating that an obstacle has been detected.

Rollixo RTS OSE – OSE stands for 'Optical Safety Edge'.

This kit is supplied with an safety edge transmitter and is connected to a Somfy optical safety edge system. The optical safety edge consists of two optical cells mounted at each end of a rubber profile. The cells project an optical beam through a hollow section of the profile, which become obscured once the rubber profile is depressed. This in turn results in a signal from the safety edge transmitter, indicating that an obstacle has been detected.

“Please refer to the Installer Guide provided with every Rollixo, here you will find the basic principles and operating parameters for any CE compliant safety edge system”

Rollixo RTS control panel

No.	Description
1	Up button
2	Stop button
3	Down button
4	Prog button
5	Prog LED
6	Motor & safety brake LED
7	Safety edge LED
8	Battery LED
9	Photocell LED

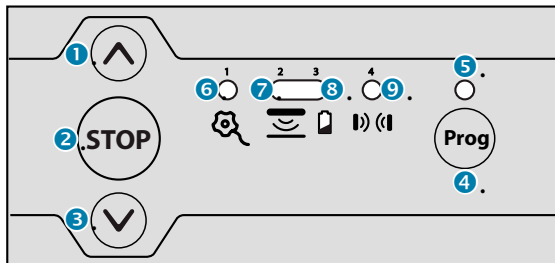

Mounting the Rollixo RTS

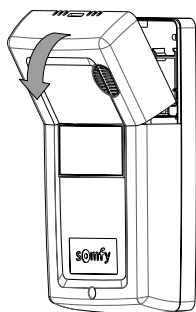

- 1** Remove the courtesy light cover.

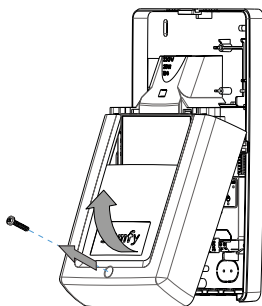

- 2** Unscrew and remove the panel cover.

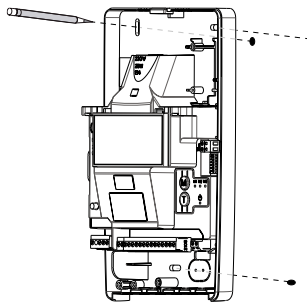

- 3** Mark the wall drilling positions.

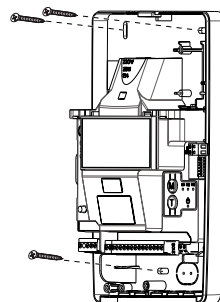

- 4** Secure the Rollixo RTS in place.

Somfy motor wiring

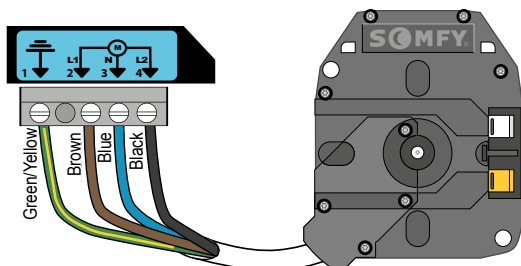

- 1** Connect the motor wires into terminals 1, 2, 3 & 4 as illustrated above.

Note: The motor direction can be reversed during the commissioning procedure.

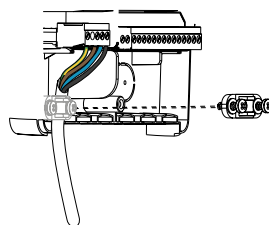

- 2** Secure the motor supply cable in place with the cable clamp.

Safety brake wiring

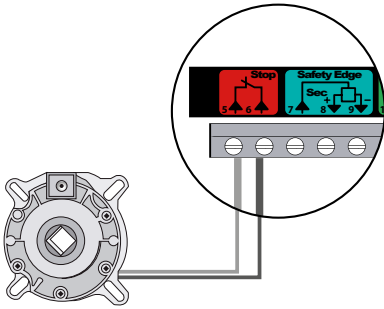

❶ Connect the safety brake into terminals 5 & 6.

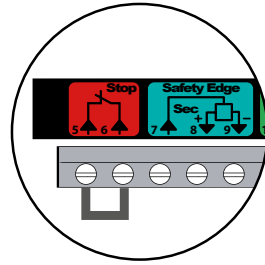

❷ Use the link provided to connect terminals 5 & 6 if no safety brake is required.

Powering up the Rollixo RTS

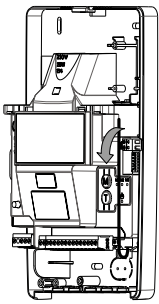

❶ Unfold the aerial so that it points vertically downwards.

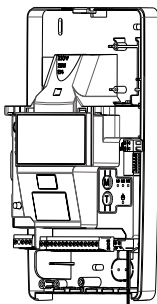

❷ Screw the bulb supplied into the light fitting.

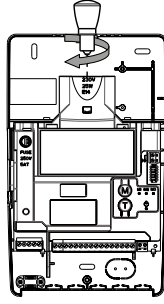

❸ Refit the panel cover and secure with the screw.

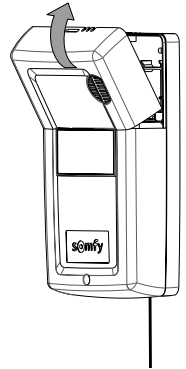

❹ Refit the courtesy light cover.

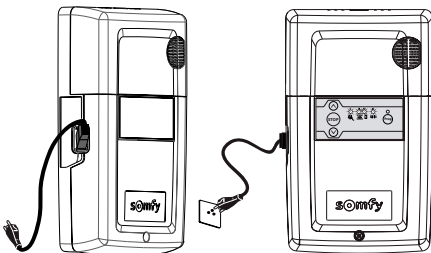

❺ Plug in the supply cable and connect the the mains supply.

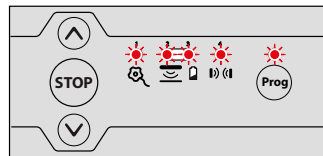

All the LED's come on briefly and then go out.



If the motor LED comes on, check the safety brake or link connection.



If the safety edge LED comes on, the safety edge transmitter has not been recognised. (This is normal if the safety edge transmitter has not been paired to the Rollixo RTS yet).

Motor direction of rotation setting

❶ Press **IN** the motor limit buttons to allow the motor to rotate during the direction and limit setting procedure.

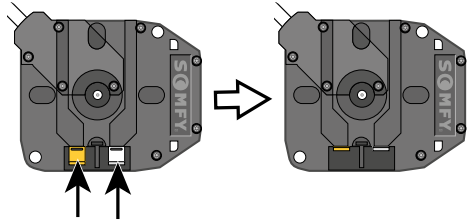

❷ At the same time press and hold the UP & DOWN buttons on the control panel until the door moves forward AND backwards, then release the buttons – the controller is now in 'motor adjustment mode', the motor LED light will flash slowly.

In motor adjustment mode, the Up & Down control buttons are in 'hold to run' mode - you must press and hold the button in to operate the door up and down.

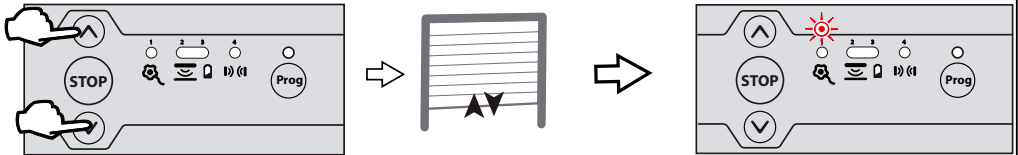

❸ Press and hold the UP button to check the motor direction

If the motor direction is correct, move on to page 7.

If the motor direction is incorrect, press and hold the STOP button until the door jogs up and down > the direction has been reversed > check again and move on to page 7.

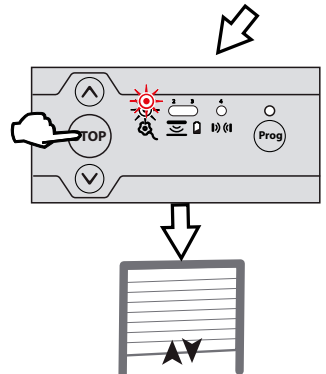
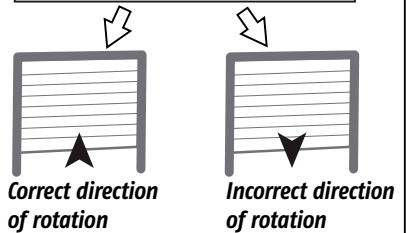
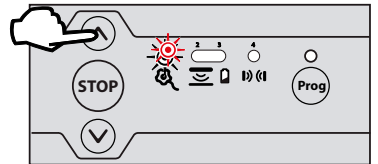

Motor limit setting

★ During the limit setting procedure, the Rollixo push button controls are in **HOLD TO RUN** mode.

❶ Motor limit directions as shutter box projects towards you.

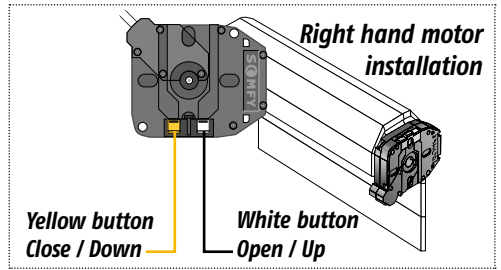
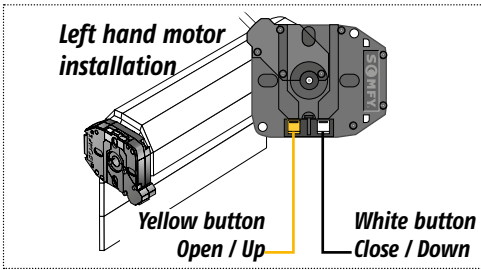

❷ Press and hold the UP button to move the door to the upper limit position (use the UP & DOWN buttons to fine tune the door to the desired position).

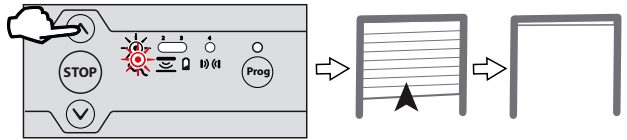

❸ Press the motor Up end limit button IN to set the 'Open/Up' limit position.

Left hand motor

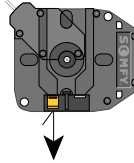

Right hand motor

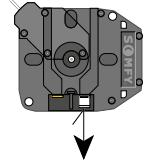

❹ Press and hold the DOWN button to move the door to the lower limit position (use the UP & DOWN buttons to fine tune the door to the desired position).

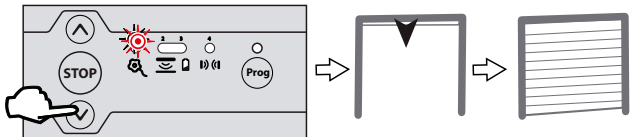

Left hand motor

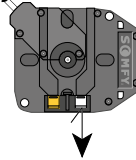

Right hand motor

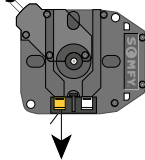

❺ Press the motor Lower end limit button to set the Close / Down limit position.

❻ Briefly press the PROG button until the door jogs to complete the motor set up procedure.

The motor & safety brake LED goes out and the safety edge LED comes on.

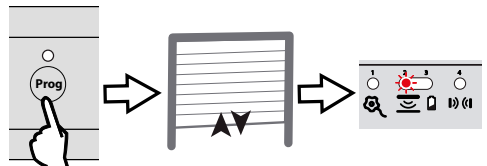

Pairing the safety edge transmitter

❶ Bring the door and the bottom rail to a workable eye level. Press and hold the 'Prog' button on the Rollixo panel until the LED light above it comes on – Then let go!

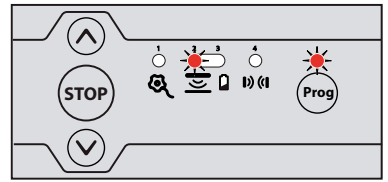
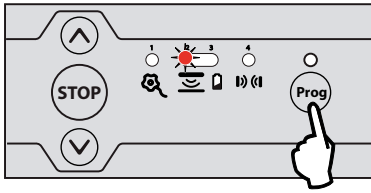
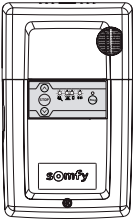

❷ Now approach the Transmitter on the Bottom Rail – Using a small tool press the 'Prog' button on the unit until the Rollixo panel 'Prog' LED flashes, then let go (this could be up to 5 seconds) the 2 units are now active.

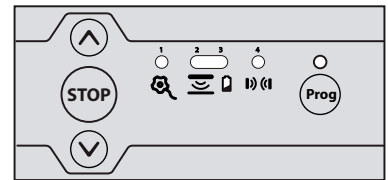
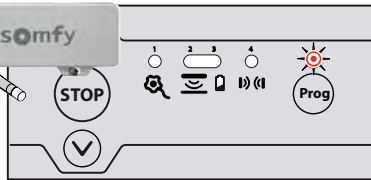

❸ Check the operation of the door by pressing the Rollixo Up & Down control buttons.

❹ Check that the safety edge works by activating the edge.

Pairing Keygo RTS keyfob's

❶ Press the 'Prog' button on the Rollixo RTS front panel until the LED above the Prog button lights up RED.

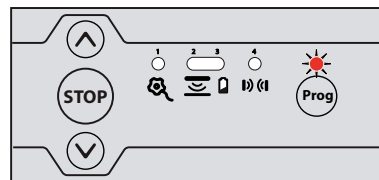
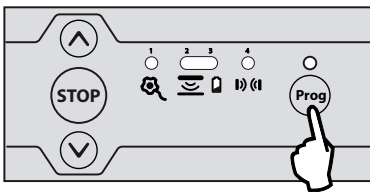

❷ Press the button on the Keygo RTS keyfob that you want to control the Rollixo RTS controller with until the 'Prog' LED on the Rollixo RTS controller flashes and then goes out.

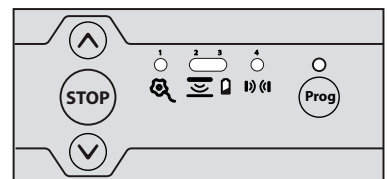
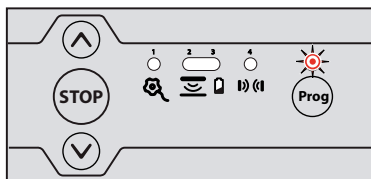

Positioning of Magnets

- 1 Bring the door down to its final closed/end limit position. If the door lands on floor and stops, go to point 2

If the door comes to floor and retracts (bounces back) then see check the detail below, this happens because the doors safety edge system has been activated;

Q. Are the end blocks sat in a final position that is lower than the floor level?

A. Raise the blocks and build up with packing.

Q. Is there a high point or bump in the floor?

A. Floor needs to be levelled.

- 2 Once you are happy that the door has been installed within its operating parameters then we can fit the bottom magnet.



Mark the guide rail at its lowest point to match the arrow indicated on the right of the Transmitter. Now move the door up out of the way and use the temporary sticky pad to locate the magnet, now permanently and mechanically fix the magnet with screws provided in place. The magnet arrows should now be aligned and no more than 10mm apart.

Locking out the Panel

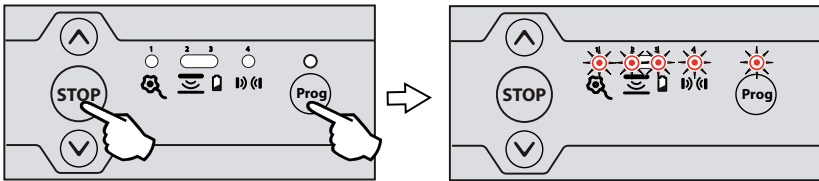
- 1 Press buttons  and  on the receiver until all the indicator lights flash.



- 2 Entry into programming mode by pressing button  on the receiver is locked.

Entry into motor end limit setting mode via pressing buttons  and  on the receiver is locked.

The parameter setting of the operating modes is locked.

Deleting all remote controls from the memory

- 1 Press the 'Prog' button on the Rollixo RTS front panel for approximately 7 seconds until the LED goes out:

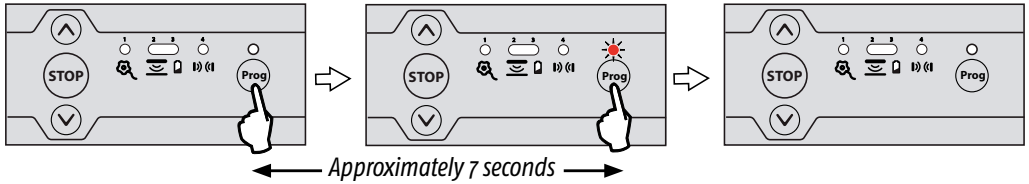

The LED will then begin to flash slowly and then go out - all remote controls have been deleted.

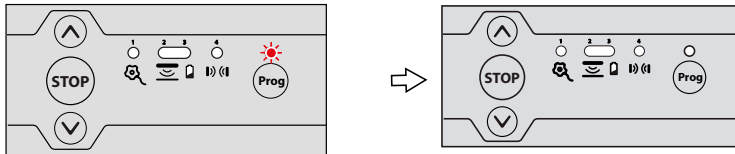

Deleting the safety edge transmitter

- 1 Press the 'Prog' button on the Rollixo RTS front panel for approximately 14 seconds:

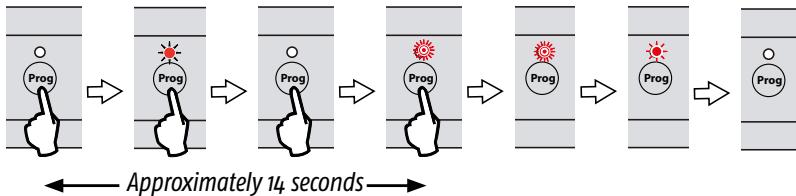

The LED will: come on - go out - start to flash rapidly - then let go of the 'Prog' button.
The LED will flash slower then go out.
The safety edge transmitter has been deleted.

Return to the factory mode

- 1 After deleting all the remote controls and safety edge transmitters from the memory:
Press simultaneously the Up & Down buttons on the front panel.

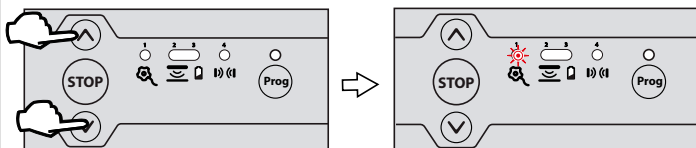

The door will jog Up & Down and the motor LED will start flashing slowly.

The Rollixo RTS control panel has now been set back to the factory mode.

Complete Check List

- Is the floor level?

- Up & Bottom limits set?

- Safety edge Transmitter waking up when tapped?

- Up, Stop & Down working correctly with Courtesy light?

- Does safety edge activate when it hits an obstruction?

- When closed is the rubber edge uniform and not deformed?

- Have magnets been fitted where necessary?

- Is the Alarm active?

- Do all the accessories and Key fobs work correctly?

- Have you locked out the panel?

- End User Demonstration?

-
-
-
-

XSE transmitter - Installation instructions

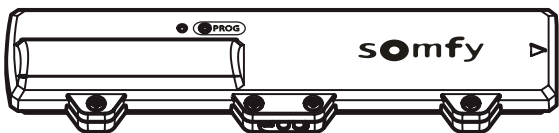

5118797A

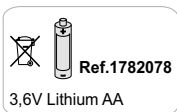
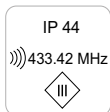
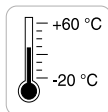

3,6V Lithium AA



SOMFY declares that this product complies with the essential requirements of applicable European directives. A Declaration of Conformity is available at www.somfy.com/ce (ROLLIXO).

1 General view of the installation

Installing the XSE transmitter inside the garage on the final slat on the right-hand side

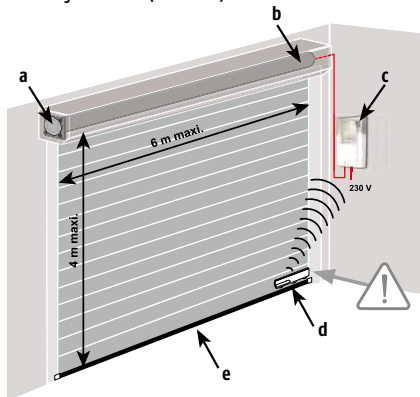

a	Fall protection
b	Motor Lt or Rt
c	Receiver Lt or Rt
d	XSE transmitter always Rt
e	Optical safety edge (OSE) or resistive safety edge (ESE)

2 Product description

The XSE transmitter is designed to be installed with an optical safety edge (OSE) or a resistive safety edge (ESE), a receiver and an RDO CSI motor approved by Somfy.

1	MODE button	Safety edge test / shipping mode
2	LED1	
3	Dipswitch 1	Adjusting the transmitter operating time
	Dipswitch 2	
	Dipswitch 3	Adjusting the sensitivity of the movement sensor
4	Dipswitch 4	Activating the upper magnet
	LED2	Commissioning (waking up/programming) the transmitter
5	PROG button	Programming the transmitter
6	Optical safety edge (OSE) connectors	
7	Resistive safety edge (ESE) connector	
8	3.6V Lithium AA battery	
9	Optical safety edge (OSE) connection tool	
10	4 fixing screws for the XSE transmitter + 2 screws for fixing the XSE transmitter to the final slat	

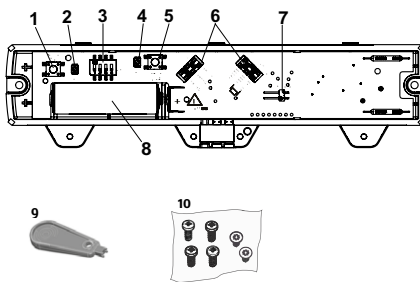

3 Routing the cables and fixing the XSE transmitter to the final slat

> In the final slat

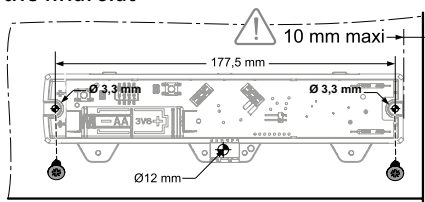
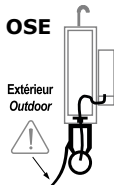
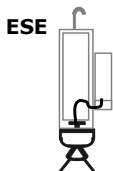

XSE transmitter - Installation instructions

> In the rubber

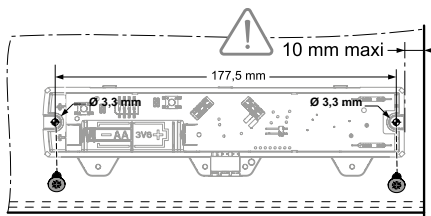
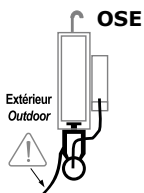

4 Wiring the safety edge on the transmitter

> Optical safety edge (OSE)

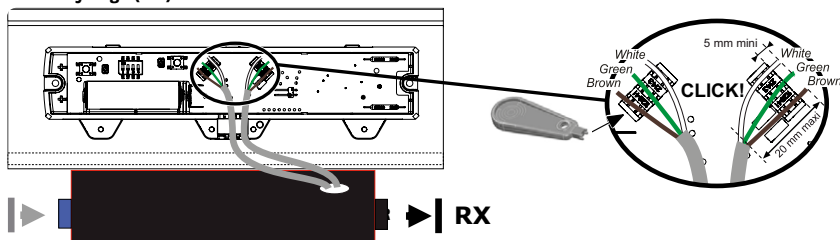

TX | ► | **RX**

⚠ Do not strip the wires. Leave excess wire on each connector (min. 5 mm). Leave excess cable in case of a new installation. If recutting cables, use a suitable tool to remove the sheath without damaging the wires.

Press down on the optical cell wires using the connection tool until you hear a CLICK.

> 1k2 or 8k2 resistive safety edge (ESE)

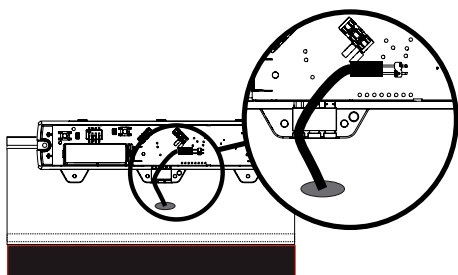

5 Installing the battery and running the automatic test

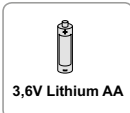
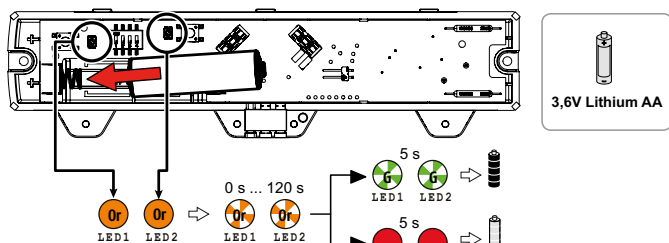

XSE transmitter - Installation instructions

6 Commissioning and testing the safety edge

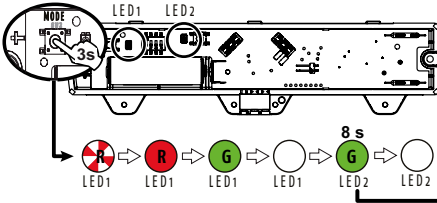

Green	Green flashing	Orange	Orange flashing	Red	Red flashing

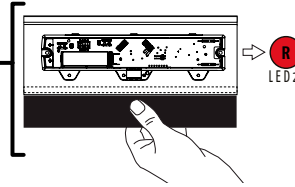

The rubber crushing test is compulsory for resistive safety edges (ESE).

7 Closing the XSE transmitter

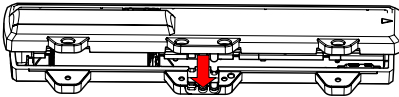

Remove appropriate tabs as required

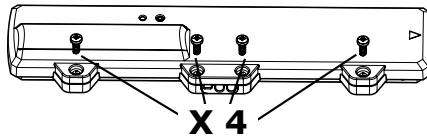

8 Installing a base magnet

> **Compulsory for resistive safety edges (ESE)**

> **Recommended for optical safety edges (OSE)**

- Installing a base magnet:
- extends the battery life
- eliminates the risk of ground detection, secures the closing of the door
- automatically activates the maximum level of sensitivity of the movement sensor
- increases the sensor operating time from 25 to 35 seconds when the base magnet is detected.

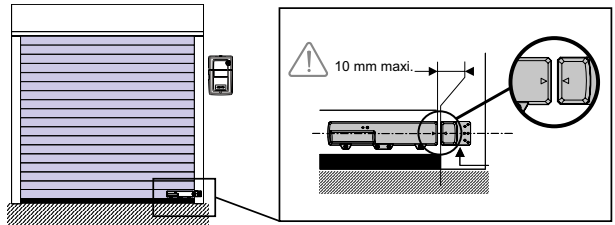

9 Programming the XSE transmitter in to the Rollixo receiver

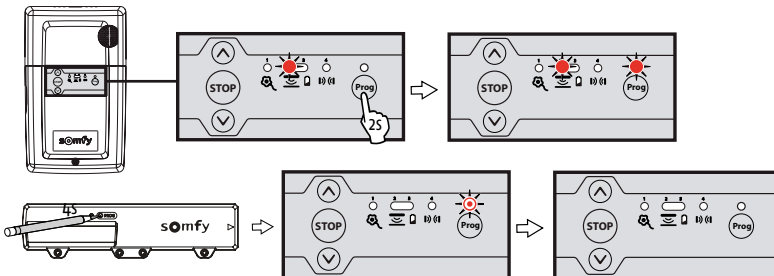

XSE transmitter – Installation instructions

10 Configuring the XSE transmitter operating time

Operating time	Dipswitch 1	Dipswitch 2
25 secs (35 secs if base magnet installed)	OFF	OFF
35 secs	ON	OFF
60 s	OFF	ON

11 Repairs

> Problem on XSE transmitter LED1 and LED2:



Stage 1: CHECK THE BATTERY

Remove the battery then press a button (PROG or MODE) to discharge the residual energy from the electronics. Refit the battery and wait for the automatic battery test to be completed (an orange light flashes to signal the test is under way – it may last up to 2 minutes).

- If LED1 and LED2 light up red for 5 seconds, replace the battery and repeat the operations above.
- If LED1 and LED2 light up green for 5 seconds, skip to step 2.

Stage 2: CHECK THE OPERATION OF THE SAFETY EDGE

Launch safety edge detection and test the safety edge

- If LED2 lights up green then the safety edge and transmitter are operating correctly. Squeeze the safety edge and check that LED2 lights up red.
- If not, go to step 3.

Stage 3: DETERMINE THE ORIGIN OF THE FAULT: XSE TRANSMITTER OR SAFETY EDGE?

Disconnect the safety edge.

Test 1: launch safety edge detection

- If LED2 flashes red for 8 seconds then the XSE transmitter is operating correctly.

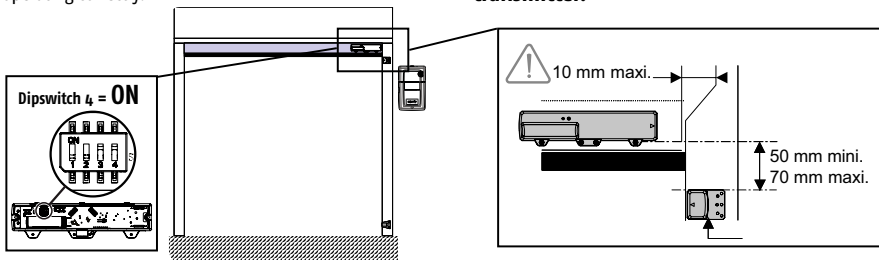

- If not, the XSE transmitter maybe faulty.

Test 2: (optional): launch safety edge detection by short-circuiting the 2 contacts on the ESE J3 connector (using a flat-blade screwdriver).

- If LED2 lights up red for 8 seconds then the XSE transmitter is operating correctly.
- If not, the XSE transmitter maybe is faulty.

If tests 1 and 2 show that the transmitter is operating correctly, replace the safety edge.

> Ground detection problem (no door deformation

Check that there is a magnet fitted as shown and install one if necessary or rectify the ground to make it level and uniform.

> Problem waking up the transmitter from fully open position

Important: For each test, wait until LED2 goes off to test that the transmitter wakes up.

Test 1: Check that the XSE transmitter is working by tapping it and check that LED2 lights up green. If not, press and hold the PROG button for 3 seconds and retest. If the problem persists, replace the XSE transmitter.

Test 2: Open the door fully, check that dipswitch 3 is ON, then retest.

Test 3: If the problem persists, install an upper magnet and set dipswitch 4 to ON then retest.

If the problem persists, replace the XSE transmitter.

12 Recycling



Never dispose of used batteries with household waste. They must be taken to the relevant recycling points.

Somfy Ltd

Moorfield Road

Yeadon

Leeds

West Yorkshire

LS19 7BN

T. 0113 391 3030

F. 0113 391 3010

E. sales.uk@somfy.com

www.rollix.co.uk